



Appliance Components Catalogue Volume 1



BRANCHES

Refer to back cover for details.

TRADING HOURS

Monday to Thursday: 07h30 - 17h00

Friday: 08h00 - 16h30

Saturday: 08h00 - 12h00

PRODUCTS

We carry an extensive range of pattern, universal and original parts and accessories for household appliances which due to the vast number of parts cannot all be included in this catalogue. We have therefore selected only the more popular parts for inclusion. Our range of original parts include spares of the following:

AEG | BARLOWS | BAUER | BOSCH
COLUMBUS | DAEWOO | DEFY
ELECTROLUX | FRIDGEMASTER
FUCHSWARE GOLDSTAR | HARWOOD
HITACHI HOOVER | IGNIS | INDESIT
KELVINATOR | KIC | LG | NATIONAL
OCEAN | SAMET | SAMSUNG | SIEMENS
SPEEDQUEEN | UNIVA VORWERK
VULCAN/PRESIDENT | WHIRLPOOL

PATTERN PARTS

The appliance parts best described and illustrated in this catalogue are suitable for use in the appliances named herein, but have been manufactured by reputable companies unrelated to the Original Equipment Manufacturers and Suppliers.





CONTENT

Category One

HOME LAUNDRY & DISHWASHER
PAGES 8 - 75



Category Two

FLOOR CARE
PAGES 76 - 99



Category Three

STOVES AND COOKERHOODS
PAGES 100 - 135



Category Four

REFRIGERATION
PAGES 136 - 161

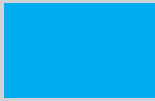

Category Five

SMALL APPLIANCES, GEYSERS & URNS
PAGES 162 - 181



Category Six

MICROWAVE OVENS
PAGES 182 - 191

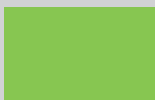

Category Seven

COMMERCIAL & CATERING EQUIPMENT
PAGES 192 - 207



© COPYRIGHT 2015

This catalogue may not be reproduced
in whole or part by any means including
photographically or electronically without the
express written permission of TESCA (PTY) Ltd.



01 Home Laundry & Dishwashers

Bearings.....	8
Bearings: and seal kits.....	10
Bearings: covers, slides and pads	12
Belts: multi 'V' belts	14
Belts: round and stretch	16
Belts: 'V' belts	16
Buffer seal and bellows	18
Capacitors	20
Dispensers: soap, rinse aid, boxes	21
Door bellows and boots	22
Door frames and portholes.....	24
Door gaskets and seals	25
Door handles, hinges, latches and parts	25
Drums: inner and outer, parts	28
Fan blowers and pulleys	29
Filters.....	29
Gearboxes: complete and parts	31
Heating elements	35
Hose fittings and plumbing accessories	36
Insulation tape	38
Hoses: external	38,40
Hoses: crushproof drain	39
Hoses: internal	41
Interlock switches	43
Knobs	44
Lids	44
Miscellaneous dishwashers	44
Miscellaneous washing machines	46
Motors: circulating and complete parts.....	47
Mounts: castors, feet and pedestals	51
Pressure switches	52
Pulleys: fan, pulsators and motors	53
Pulsator housings: complete and parts	55
Pulsator and agitators	55
Pumps: Drain	57
Seals: oil and circular	61
Seals: felt, gearbox and carbon face	63
Solenoid valves: high pressure	63
Spin tubs: complete and parts	65
Suspensions, shocks, dampers and pads	66
Switches: door, temperature and mains	68
Thermals overloads and toc's	70
Thermostats	70
Thermostats – auto	71
Timers and control units	72
Venting kits and parts	75



02 Floorcare

Bags: cloth	78
Bags: disposable paper	79
Belts – flat, round and grooved	89
Brushes: agitator, bristles, wax and discs	91
Carbon brush pairs and holders	92
Filters: cartridge, cloth and exhaust	93
Hoses: assemblies, ends and parts	94
Motors: complete and parts	97
Switches: foot and mains	98
Tank caps, feed hoses and parts	99

03 Stoves & Cookerhoods

Cleaning agents	102
Cookerhood filters	103
Cookerhood glass	103
Cookerhood parts	103
Oven door seal matrix	104
Door catches, handles and strikers	104
Door hinges and parts	105
Door seals	106
Elements: bake, grill and warmer	106
Fuses: cartridge, screw and holders	113
Indicators and neon pilot lights	114
Knobs: control and clips	115
Lamps: globes, holders and parts	120
Miscellaneous	121
Pans: bake trays, roast broilers	121
Plates cups and rings	122
Solid plate matrix	124
Rotisseries: motors, spits and handles	125
Seals: hob, frame and glass	125
Switches	125
Rocker switch matrix	129
Terminals: blocks, covers and lugs	131
Thermofans: motors and blades	132
Thermostats and thermometers	133
Timers and control units	135
Wire	135



04 Refrigeration

Baskets	138
Capacitors	138
Compressor size guide	139
Domestic compressors	140
Rotary compressors	140
Control units	140
Copper tubing	141
Special gaskets	142
Door handles	143
Door latches, hinges and bushes	143
Door locks and keys	145
Dryers	145
Evaporator plates	147
Feet	147
Gas regulators and conversion kits	148
Insulation	148
Heater mats	148
Heating elements	148
Ice makers: complete and parts	151
Lamps	152
Miscellaneous	152
Motors: complete and parts	153
Overloads, relays and klixons	155
Pumps: coolers and ice makers	156
Refrigerants and flushing agents	157
Service accessories	157
Switches: lights and fans	158
Thermometers	158
Thermostats	158
Timers: defrost	160
Trays: drip and ice	160
Valves	161
Water filters	161

05 Small Appliances, Geysers and Urns

Ceiling fans	164
Cleaning agents	164
Connectors	164
Ceramic heater bar	165
Quartz heater bar	166
Plug tops	167
Elements	167
Elements: geysers	167

Heater: Oil elements	171
Elements: kettles	172
Elements: gaskets and spanners	172
Elements: grillers and hot trolleys	173
Food mixers	173
Heater oil	174
Hot plates	174
Microtemps	174
Pressure cooker parts	175
Switches: thermostats	178
Switches	180
Urn taps and tap washers	181

06 Microwave Ovens

Belts	184
Capacitors: high voltage	184
Couplings: centre drive and roller rings	185
Diodes	185
Fuses	186
Lamps	186
Magnetrons	187
Motors	188
Paint	188
Switches	188
Thermostats	189
Timers and control units	189
Transformers	189
Trays	190

07 Commercial & Catering Equipment

Belts	194
Elements	194
Elements: urns	202
Elements: grillers	203
Elements: infra-red	203
Heating elements	204
Knobs	204
Miscellaneous	205
Seals	205
Thermostats, thermometers and switches	205



01

HOME LAUNDRY & DISHWASHERS



BEARINGS

BRG6006

30x55x13mm

BRG6200

10x30x9mm

BRG6201

12x32x10mm

BRG6202

15x35x11mm

BRG6203

17x40x12mm

BRG6204

20x47x14mm

BRG6205

25x52x15mm

BRG6206

30x62x16mm

BRG6207

35x72x17mm

BRG6305

25x62x17mm

BRG6306

30x72x19mm

BRG6309

45x100x25mm

BRG607

7x19x6mm

BRG608

8x22x7mm

BRG609

9x24x7mm



BRG625

30x55x13mm

BRG626

10x30x9mm

BRG627

15x35x11mm

BRG629

17x40x12mm

BRG635

25x52x15mm

BRG6001

30x62x16mm

BRG6002

25x62x17mm

BRG6003

30x72x19mm

BRG6004

7x19x6mm

BRG6005

8x22x7mm



BEARING AND SEAL KITS



A245

HUB BEARING AND SEAL KIT
INDESIT A.F.L
WN461WO
WN657WF/Z
WN663WO

DY02

HUB BEARING AND SEAL KIT
DEFY AFL
DAW350 / DAW361



DY28

HUB BEARING AND SEAL KIT
DEFY A.F.L - all automaid
washers, DEFY washer/dryer
kombomaid
MKI, MKII, DW506

DY86

HUB BEARING AND SEAL KIT
DEFY automaid
'DAW' series from
DAW285 late



E129

HUB BEARING AND SEAL KIT
KELVINATOR AFL - A205,
A205, A2005, A2006, A5500,
A5501, A5502, A5503,
A5513, A5600, A5601, LADY
'K', WAF50NNR, WAF60NNR

EC119

HUB BEARING AND SEAL KIT
BAUER - AFL 550; DAEWOO
- DX550, DX600T; HOOVER -
HW600; KIC - W600K;
MERCURY 518U;
UNIVA - 550

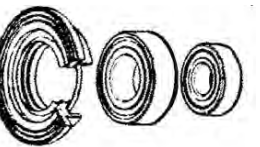

G127

HUB BEARING AND SEAL KIT
AEG AFL - 505, 505N, 509,
509N, 520, 528, 538, 541,
570, 621

KM048

HUB BEARING AND SEAL KIT
HOOVER AFL - all 800RPM
models



BEARINGS: COVERS, SLIDES, PADS



BAD860352

BEARING COVER PLATE
KELVINATOR tumble dryer -
N130, N140, T50WF; DEFY
autodry 5 series
ORIGINAL PART

BAD860358

BEARING WASHER
KELVINATOR tumble dryer -
N130, N140, T50WF; DEFY
autodry 5 series
ORIGINAL PART



BAD860359

BEARING SPACER
KELVINATOR tumble dryer -
N130, N140, T50WF; DEFY
autodry 5 series

D65595

BEARING STRIP
DEFY tumble dryer - DTD252
-DTD258
-DTD259





DY17

BEARING LINING - 2 metre
DEFY tumble dryer -
autodrier 3.6, autodry 36,
autodry 45, sensimatic 45,
varidry



DY64

BEARING LINING - 913mm
DEFY tumble dryer - autodry
5: D150, 'DTD' series



E135

DRUM BEARING BOLT
KELVINATOR tumble dryer -
N130, N140, J2500, J2501,
J2502, J2503, T50WF
OEM REF: AD860320



E139

DRUM BEARING KIT
KELVINATOR tumble dryer -
N130, N140, T50WF; OCEAN
tumble dryer - OTD201



KL-DE00-156

FRICTION BLOCK
KELVINATOR dryer -
KTD61W/M



KL-DE00-309

GLIDE BRACKET
KELVINATOR dryers - LES33,
AEM477



PN-AD510145

GLIDE BRACKET
SPEEDQUEEN dryers - LES33,
AEM477



PN-AD510187

GLIDE, CYLINDER S/Q DRIERS
SPEEDQUEEN dryers
- later models



PN-AD61448

BEARING TRAILING PAD
SPEED QUEEN tumble dryer
- EARLIER models
ORIGINAL PART



BELTS: MULTI 'V' BELTS

PART NUMBER	METRIC	IMPERIAL	SUITABLE FOR
LG-010	1120J4	Pattern	LG DRYER - WT80134T, WD80250NP, WD80490TP
LG-MAS42413101	1120J5	Original	LG AFL - WD80250NP, WD80490TP
KL-3616591300	1134J3		KELVINATOR AFL - KL600FL
LG-4400FR3116D	1120J5		LG AFL - WD8050F, WD10165FU, WD80130F, WD80100TP
KL-00214400002200	1190J5		KL55/60 KELV
4812 358 18182	1220J5		WHIRLPOOL DRYER - AWZ460, AWZ930
4812 358 18206	1242J5		WHIRLPOOL AFL - AWT8125, AWM3000
4819 358 18143	1243H8		WHIRLPOOL AFL - AWM245
D2816750100	1244J4		DEFY AFL - DAW322, DAW323
DY93	1245J5	490J6	DEFY AUTOMAID - DAW240, DAW245
4819 358 18152	11248J5	492J5	WHIRLPOOL AFL - WA3700, AWM243/3, AWM5050, AWM6100
4812 358 18056	1250J5		WHIRLPOOL AFL - AWM250
D2810260100	1270H7		DEFY AFL - DAW366
G141	1270J5	500J5	AEG 500 SERIES AFL, KELVINATOR AFL - KL750CM;SAMSUNG B1215
D2005170400	1277J5		DEFY DAW351/2; DAW315; DAW316; DAW352
4819 358 18024	1315J5	518J5	WHIRLPOOL AFL - AWG729, AWG736/7
KM046	1372J5	540J5	HOOVER AFL - ALL 800 RPM MODELS
DY37	1600J3	630J3	DEFY AUTODRY - TD300, TD67
KL-421309218601	1810J3	713J3	KELV DRYER - KTD60, KIC - CT311
E120	1854J3	730J3	DEFY AUTODRY 5, KELVINATOR - N130, N140
A195	1885H8		INDESIT TUMBLE DRYER - SG511X, SAMET TUMBLE DRYER
EC105	1904H7		DAEWOO - DT5, BAUER/MERCURY - TD5,

PART NUMBER	METRIC	IMPERIAL	SUITABLE FOR
HTD13	1905J3	750J3	HOOVER TUMBLE DRYER - LATE MODELS, PHILIPS TUMBLE DRYER
KL-DE00-120	1915H6		KELV KTD600W
A128	1930H6		INDESIT DRYER - SG511X - 56510X
G151	1930H7		AEG TUMBLE DRYER - 320, 610, 56600
4812 358 18164	1936H6		WHIRLPOOL AFL - AWL633. AWL635
4213 078 47721	1956J3	770L3	WHIRLPOOL T/DRYER : AWG274, CT511
TD674	1956J3	770J3	HOOVER TUMBLE DRYER - EARLY MODELS
4812 358 18186	1965H6		WHIRLPOOL AFL - AWL205
D2953240200	1967H9		DEFY DRYER - DTD294
G152	1975H5		AEG T/D CAVATHERM T3
DY27	1981J3	780J3	DEFY AUTODRY - 36, 45
LG-4400EL1001A	1985H8	ORIGINAL	LG DRYER - TD-V75120E, TD-V75125E
LG-018	1985H8	PATTERN	LG DRYER - TD-V75120E, TD-V75125E

4819 358 18117

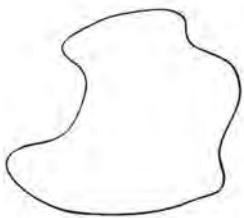

ORIGINAL BELT

WHIRLPOOL T/ DRYER: GLE5700, 3LER5434, 3LER5436

D12894



FLAT BELT

DEFY TUMBLE DRYER - DTD236, DTD237

PN-AD56095



ORIGINAL PART

SPEEDQUEEN TUMBLE DRYER NE5313

PN-510178



ORIGINAL BELT

SPEEDQUEEN TUMBLE DRYER AEM 477 / REM477, LES33



▶ BELTS: ROUND, STRETCH AND MULTI 'V' BELTS

▶ DY22

▶ G100

▶ HIT2



DEFY AUTODRY 36/45,
SENSIMATIC 45,
VARIDRY



AEG TUMBLE DRYER FAN BELT



HITACHI TUMBLE DRYER

PART NUMBER	SIZE	METRIC	IMPERIAL	SUITABLE FOR
▶ KL-3616590220	9mm x 521mm		M20.5	KELVINATOR TOP LOADER - KL15TL
▶ KL-3616590230	9mm x 535mm		M21	KELVINATOR TOP LOADER - KL15TL, DEFY - DTL125, DTL128, DTL130, DTL132
▶ 4504B00020	9mm x 635mm		M25	KIC TWIN-TUB - TT524
▶ KL100TT2-57K	9mm x 670mm			KELVINATOR TWIN TUB - KL100TT2 BAUER TWIN TUB XPB7
▶ KLL72TT65K	9mm x 690mm			KELVINATOR TWIN TUB - KLL72TT
▶ KL80TT67K	9mm x 720mm		M28,5	KELVINATOR TWIN TUB - KL80TT
▶ KL-00330011021	9mm x 793mm			BAUER - TTW9, KELVINATOR - KL90TT
▶ LG-2W50155K	9mm x 793mm		M31	LG TOP LOADER - WP-9916T
▶ KL-0020300054	9mm x 1245mm			KELVINATOR AFL - KL60DFL
▶ LG-3921FZ4006C	10mm x 520mm		M20.5	LG TOP LOADERS - T6507TD, T8011DFP, WF-8071TP, WF-T7014PP, WP-T7015TP, WF-T7016PPP
▶ S-DC66-10045B	10mm x 522mm		M20.5	SAMSUNG TOP LOADER - SW5
▶ TF700-318	10mm x 525mm		0-525-E	KELVINATOR TOP LOADER - KL72TL
▶ NT6330-109	10mm x 550mm			NU-TEC -- NTA6330
▶ S-6602-001151	13mm x 560mm		A22	SAMSUNG TWIN TUB - WT13J, WT16J
▶ S-DC66-10142A	10mm x 558mm		M22	SAMSUNG TOP LOADER - WA1385
▶ D66886	10mm x 612mm			DEFY TWIN TUB DTT 164; DTT165

PART NUMBER	SIZE	METRIC	IMPERIAL	SUITABLE FOR
KL-PI288S-048	10mm x 638mm			KELVINATOR TWIN TUB - KLL13TT
NT5500-010	10mm x 655mm			NU-TEC TWIN TUB - NTT5500
LG-4400FW2096C	10mm x 660mm		M26	LG T/LOADERS - T1003, T8517, WF-T8018, WF-T9018TP, WF-T9230
NT6500-008	10mm x 685mm			NU-TEC TWIN TUB - NTT5500/NTT6500
LG-4400FW2096A	10mm x 775mm		M30.5	LG TWIN TUB - WP1300, WP8200QS, KELVINATOR - KLL13TT
4819 358 18115	10mm x 1210mm		3L47	WHIRLPOOL AFL - FL243, WHIRLPOOL COMBO - AWG336; KELVINATOR - KM44
47112	10mm x 1230mm			INDESIT AFL - WG521, WG623, WG635TS
EC106	10mm x 1273mm	9ML127	3L501	HOOVER AFL - HW600; KIC AFL - W600K; BAUER - 550, UNIVA - 518U, MERCURY 518, SAMSUNG - SW6004
E118	10mm x 1320mm		3L520	BARLOWS AFL - A160; AEG AFL - 400F
DY44	10mm x 1370mm		3L540	DEFY 'DA' & 'DAW' SERIES; KELVINATOR AFL - A5500
DY90	13mm x 570mm			DEFY TWIN TUB - ESE550
TF65-208	13mm x 620mm			TELEFUNKEN TWIN TUB - TTT65
HA20908	13mm x 660mm			KELVINATOR TWIN TUB - KL85TT, DEFY - DTT146
KL-07010988S	13mm x 670mm			KELVINATOR TWIN TUB - KL100TT2/3/M
HS102041	13mm x 675mm	A675		HISENSE TWIN TUB - XPB60-2000S/SA
S-DC66-10144B	13mm x 685mm		A27	SAMSUNG - WT10J7, WT10S2P
HA10301	13mm x 735mm			TWIN TUBS - AIM - ATT5, BAUER - TT800, / TTW4 DEFY - DTT130/135, FRIDGEMASTER - WA56P, HISENSE - XPB80
PN-AB28043	ORIGINAL BELT			SPEEDQUEEN TOP LOADER - HA4011
PN-AB33843	ORIGINAL BELT			SPEEDQUEEN TOP LOADER - NA3311
PN-AB35517	ORIGINAL BELT			SPEEDQUEEN TOP LOADER - AWM372; AWN270; AWM373
PN-AB38749	ORIGINAL BELT			SPEEDQUEEN TOP LOADER - LWS11A/LWS21A; SWT211
PN-AB39435	ORIGINAL BELT			SPEEDQUEEN TOP LOADER - LWS11A/LWS21A; -NEW



BUFFER SEAL AND BELLOWS



DW003

SPIN BUFFER ASSEMBLY - 12mm BUSH
DAEWOO twin tub - DW7020



DY95

SPIN BUFFER ASSEMBLY - 17mm BUSH
DEFY twin tub - ESE550SWP, SW500P - with plastic ring
OEM REF: 023585



H17

SPIN BUFFER ASSEMBLY - 17mm BUSH
HITACHI twin tub - PS90P, PS330, PS520K



H25

SPIN BUFFER ASSEMBLY - 14mm BUSH
HITACHI twin tub - PAS123P, PS107P, PS400K, PS420, PS550K, PS620K, PS8200P, PS8800P, PS91P, PS92P, PS94P, PS970K, PS70P;
SAMSUNG/KIC TWIN TUB - PAL400S, PAL600S, SW401, SW420, SW600, SW620, SW650; HOOVER - H600P
OEM REF: PS-8600 021



HA-013

SPIN BUFFER - 12mm BUSH
BAUER - TTW9

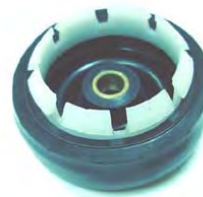

HA-112

SPIN BUFFER ASSEMBLY - 12mm BUSH
BAUER - TTW4



HA11108

SPIN BUFFER ASSEMBLY - 15mm BUSH
twin tubs : AIM - ATT5, BAUER - TT800, DEFY TWINMAID - DTT130, DTT135, DTT140, DTT141, DTT142, fridgemaster - WA56P, HARWOOD - WA56P, SVASA - WA56P, UNIVA - UT600



HA20105

SPIN BUFFER ASSEMBLY - 15mm BUSH
DEFY - DTT146/148
DTT 152 / 154 / 156 / 160 / 164 / 165 / 166 / 171



KL-302751200001

SPIN BUFFER - 14mm BUSH
KELVINATOR TWIN TUB - KL14TT



KL100TT2-56K

SPIN BUFFER - KL100TT2/3, KLL13TT
KELVINATOR twin tub - KLL100TT2



KLL13TT-01

SPIN BUFFER
KELVINATOR twin tub - KLL13TT



KLL72TT70K

DRAIN BELLOWS
KELVINATOR TWIN TUB - KLL72TT, KL100TT2



LG-002

SPIN BUFFER ASSEMBLY - 16mm BUSH
LG twin tubs -
WP8800/9800 /
9916PT
WP9914
WP8200
OEM REF: 2W06835A



LG-034

BELLOWS ASSEMBLY - WP1100QS / WP1300QS LG TWINTUBS
twin tub: P1160, P1360,
P1400, P1860, WP1100,
WP1300



N03A

BUSH FOR SPIN BUFFER - 14mm
BUSH NATIONAL twin tub -
T350, T450, T550
OEM REF: J800084



TEC05

SPIN BUFFER ASSEMBLY - 14mm BUSH
CONTI/TELEFUNKEN/
SUNBEAM twin tub -
TTT850



TSS02

SPIN BUFFER SAMSUNG - WT1052P, WT8052 KL14TT, WT13J7P Kelvinator KL14TT



TSW01

SPIN BUFFER ASSEMBLY - 14mm BUSH
HOOVER twin tub - HX606;
NU-TEC - NTT5500,
NTT6500; NATIONAL twin
tub - TA1200, T600, T2600,
T2601/1; LG twin tub -
WP7100, WP8100, WP8050,
WP8200P; MAGIC WASH
twin tub - WM6600; STAR-
WASH twin tub - TORNADO
XPB30
OEM REF: HX657-58



CAPACITORS

CAP02 2uf / 450V

CAP03 3uf / 450V

CAP03/7 3uF + 8uf / 450V

CAP03/8 3,8uf + 8uf / 450V

CAP04 4uf / 450V

CAP04/10 4uf + 10uf / 450V

CAP05 5uf / 450V

CAP05/10 5uf + 10uf / 450V

CAP05/12 5uF + 12uf / 450V

CAP05/14 5uf + 14uf / 450V

CAP06 6uf / 450V

CAP06/12 6uF + 12uF / 450V

CAP06/13 6uf + 13uf / 450V

CAP06/14 6uf + 14uf / 450V

CAP08 8uf / 450V

CAP09 9uf / 450V

CAP10 10uf / 450V

CAP12 12uf / 450V

CAP13 13uf / 450V

CAP14 14uf / 450V

CAP16 16uF / 450V

CAP18 18uf / 450V

CAP20 20uf / 450V

CAP25 25uF / 450V

CAP30 30uF / 450V

CAP35 35uF / 450V

CAP40 40uF / 450V

CAP43 43-52MFD / 250V

CAP43/52 52uF / 250V

CAP45 45uF / 450V

CAP47/56 47-56uf / 250V

CAP50 53-64uf / 250V

CAP50-450 50uf / 450V

CAP60 60uf / 450V

CAP64/77 64-77uf / 250V

CAP70 70uf / 450V

CAP88/106 88-106uf / 250V

CAP108/130 108-130uf / 250V

CAP130/156 130-156uf / 250V

CAP145/174 145-174uf / 250V

CAP161/193 161-193uf / 250V

CAP189/227 189-227uf / 250V

CAP216/259 216-259uf / 250V



DISPENSERS, SOAP: RINSE AID

4819 418 68207



DETERGENT DISPENSER ASSEMBLY
WHIRLPOOL dishwasher -
ADG635W ADP751
ORIGINAL PART

DY82



DETERGENT DISPENSER ASSEMBLY - 2 SOLENOIDS
DEFY dishwasher
Recent models;
INDESIT dishwasher
D3000WI,
D5000 series,
Lead KLEENMAID
Dishwasher - Crystal
OEM REF: LEZ201AA1

G133



DETERGENT DISPENSER ASSEMBLY - SINGLE SOLENOID
AEG dishwasher
FAVORIT 525;
INDESIT dishwasher -
KELVINATOR
KD12DW - WHITE
D3000WI,
D3050WI,
D4000 series,
DG5000,
DG5100
OEM REF: 104789

KL-674000800032



DISPENSER
KELVINATOR dishwasher
KD12DW / GREY
KD12D55-2

LG-4924FD2123E



DISPENSER
Dishwasher:
D1417,
D1419,
D1420,
D1421,
D1422,
LD-2050,
LD-2052,
LD-2060,
LD-2120,
LD-2131,
LD-2157



DOORS: BELLOWS, BOOTS



4812 466 68775

DOOR BOOT
WHIRLPOOL AFL - FL243,
FL5053
ORIGINAL PART



4819 466 69828

DOOR BOOT
WHIRLPOOL AFL - AWG372,
AWG376, AWL352, AWM807,
AWM815, AWM875; PHILIPS AFL
- AWB006, AWB071, AWB304E,
AWM940
ORIGINAL PART



4819 468 18285

DOOR BELLOWS
WHIRLPOOL combo:
AWG336/1



A101

DOOR BOOT
INDESIT AFL - 090, 091, 092, 097,
099, 101, 2089, 2091, 2092, 2093,
2094, 2095, K3, K5 series, L5, L6
series, L8, L10, LIMPPIA, LIMPPIA DUE
INOX, W400F, W410F, W411F
OEM REF: GCE015AB1



A135

DOOR BOOT
INDESIT AFL :
WG623/635/836
OEM REF: 047099



A212

DOOR BOOT
INDESIT AFL - 2097, 2099,
2101, LIMPPIA TRE, W420 series,
W421 series, W600 series,
WN461WO, WN657WF/Z,
WN663WO
OEM REF: GCE016BA1



BS06

DOOR BOOT
BOSCH AFL - WFD1060,
WFL120
OEM REF: 354135



BS10

DOOR BOOT
BOSCH / SIEMANS WFB1005
/ WFB1640
OEM REF: 296514

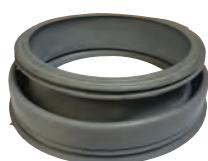

BS14

DOOR BOOT
BOSCH
OEM REF: 252600



D2804860200

DOOR BOOT
DEFY - AFL DAW351,
DAW315 / DAW316,
DAW352, DAW365, DAW366
ORIGINAL PART



D2807710200

DOOR BOOT
DEFY AUTOMAID - DAW350
/ FLAT EDGE
ORIGINAL PART



D2814440100

DOOR BOOT
DEFY AFL - DAW356,
DAW317, DAW322,
DAW323, DAW355



DY01

DOOR BOOT
DEFY AFL - AUTOMAID MK.I, AA
thru AH, DA504, DA505, DA508
DA656; DEFY WASHER/DRYER
- KOMBOMAID: MK.I, MK.II,
DW506
OEM REF: 020097



DY62

DOOR BOOT
DEFY AFL - DA455, 'DAW'
series (MK.4)
OEM REF: 023533



DY97

DOOR BOOT
DEFY KOMBOMAID -
DAW240
OEM REF: 026270



E105

DOOR BOOT
KELVINATOR AFL - KM46



G112

DOOR BOOT
AEG AFL 505, 505N, 509,
509N, 510, 520, 525, V528,
530, 538, 540, 541, 570, 620,
621, 633, 650, 680, 1000
OEM REF: 645117724



KL-KL750CM-26

DOOR BOOT
KELVINATOR AFL - KL750CM



LG-014

DOOR BOOT
AFL: WD80130, WD10165F,
WD1295FB
OEM REF: 4986ER1003A



LG-023

DOOR BOOT
LG AFL - WD80134T, WD10485T,
WD80100TP, WD10480TP,
WD10655TP, WD80490TP
OEM REF: 4986ER1005A /
4986EN1003A



LG-4986ER1005C

DOOR BOOT
AFL: F1056, F1222, F1256,
WD-12331, WD-12336



E102

DOOR BOOT
KELVINATOR AFL - A205,
A2005, A5500, A5501,
A5502, A5503, A5513,
WAF50NNR
OEM REF: EZ835478



EC108

DOOR BOOT
HOOVER AFL - HW600, KIC - W600K,
UNIVA - 550, DAEWOO DX550, 600T;
MERCURY - 518U; SAMSUNG AFL-
SW6004; BAUER - 550
OEM REF: 404000600



KL-0020300504

DOOR BOOT
KELVINATOR AFL - KL55,
KL60DFL



KM095

DOOR BOOT
HOOVER AFL - A2020, A2024, A2074,
A2096, A2126, A2142, A2166, A2168,
A2170, A2218, A2286, A2298, A2388,
A2428, A2480, A2600, A2640, A2686,
A2688, A2699, AB002, AB069, A2826
(round door) OEM REF: 674633



LG-019

GASKET
Dryer: RC8001, TD-C70040,
TD-C70045, TD-V75125
OEM REF: 4986EL1003A



LG-026

DOOR BOOT
LG AFL WD80250NP
WD80264NP, WD80490
OEM REF: 4986EN1001A



L12

DOOR BOOT
PHILIP AFL - AWB006,
AWB071, AWB304E,
AWB940



DOORS: FRAMES, PORTHOLES

D22964



OUTER DOOR FRAME - WHITE
DEFY AFL - DA455, 'DAW' series (MK4); DEFY tumble dryer - autodry 5: D150, 'DTD' series
ORIGINAL PART

D63035



OUTER DOOR
DEFY autodry series
DTD252

D63038



BRACKET, DOOR SAFETY
DEFY tumble dryer - DTD252

D64707



DOOR ASSEMBLY
DEFY TUMBLE DRYER
A/DRY SERIES 6
DTD256 METALLIC

LG-3581EN1002A



DOOR ASSEMBLY
LG AFL WD - 0480TP/10650TP/
80100/80490

LG-3581ER1009C



DOOR ASSEMBLY
LG AFL

DOORS: GASKETS, SEALS



BS02

GASKET
BOSCH D/W
OEM REF: 107650



D67952

DOOR GASKET
DEFY TUMBLE DRYER
A/D 6 SERIES
DTD252 / DTD256 / DTD258
/ DTD259



D720011

DOOR SEAL
DEFY tumble dryer - autodrier 3.6, autodry 36, autodry 45, sensimatic 45, varidry
ORIGINAL PART



DY99

DOOR SEAL
DEFY tumble dryer - DTD252
DTD242 / DTD254
OEM REF: 64652



DY100

DOOR SEAL
DEFY tumble dryer - autodry 5: D150, 'DTD' series
OEM REF: 023333



G124

CABINET GASKET
AEG dishwasher - FAVORIT 123, 124, 525, 625
OEM REF: 646401813



HTD12

DOOR SEAL
HOOVER tumble dryer - D6008
THRU D6208
OEM REF: 647353



HTD19

DOOR SEAL
HOOVER tumble dryer -
D6296 THRU D6893
OEM REF: 955096



KD12DW2003K

GASKET, BOTTOM
KELVINATOR dishwasher -
KD12DW



LG-019

GASKET
LG TUMBLE DRYER
Dryer: RC8001, TD-C70040,
TD-C70045, TD-V75125
OEM REF: 4986EL1003A



LG-3920DD3006A

TUB PACKING
LG DISHWASHER
LD-2040, LD-2050, LD-2060,
LD-2131, LD-2157, LD-2162

DOORS: HANDLES, HINGES, LATCHES, PARTS



4819 492 48144

DOOR LATCH SPRING
WHIRLPOOL AFL - AWG372,
AWG376, AWM807,
AWM815, AWM875, KW600
ORIGINAL PART

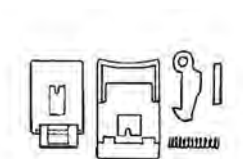

4819 498 69837

DOOR LATCH KIT
WHIRLPOOL washer/dryer -
AWG336; MERCURY washer/
dryer
ORIGINAL PART



A116

DOOR CLOSER
INDESIT dishwasher -
DG5100
OEM REF: 044831



A120

DOOR HANDLE
INDESIT dishwasher -
DG5000/5100



BAD880015

DOOR HINGE
KELVINATOR tumble dryer -
J2500, J2501, J2502, J2503
ORIGINAL PART



BS07

DOOR LATCH KIT
fits BOSCH, SIEMENS, BALAY
OEM REF: 069637



BS15

DOOR HINGE KIT
BOSCH AFL - WFB-
1000BY/01
OEM REF:153150



BS183607

HANDLE, BOSCH -
WFD1060ZA/1
BOSCH AFL -WFD1060ZA/1



BS183608

LATCH, DOOR - BOSCHW-
FD1060ZA/1
BOSCH AFL - WFD1060ZA/1



D061709

DOOR HANDLE
DEFY AUTOMAID - DAW310
A/WASHER SERIES 6
ORIGINAL PART



D2804940800

DOOR HANDLE
DEFY AFL
DAW351 / SILVER



D3612608200

DOOR HANDLE
DEFY AFL
DAW360



D60643

HINGE HOUSING
DEFY TUMBLE DRYER
DTD252 / DTD258 / DTD259



D63031

DOOR CATCH
DEFY tumble dryers - DTD252,
DTD254, DTD256 - autodrier 3.6,
autodry 36, autodry 45, sensimatic
45, varidry
OEM REF: 9720044 ORIGINAL PART



DY14

DOOR LATCH 'E' SPRING
DEFY AFL - automaid MKI, AA
thru AH, DA504, DA505, DA508,
DA656, DEFY washer/dryer -
kombomaid: MKI, MKII, DW506
OEM REF: 008988



DY40

DOOR LATCH
DEFY AFL - automaid MKI, AA
thru AH
OEM REF: 012496



DY58

DOOR LATCH
DEFY AFL - DA455, 'DAW'
series (MK4); DEFY tumble
dryer - autodry 5: D150,
'DTD' series
OEM REF: 027235



DY80

DOOR HINGE
DEFY AFL - DA455, 'DAW'
series (MK.4), DEFY tumble
dryer - autodry 5, D150,
'DTD' series
OEM REF: 025827



EC110

DOOR LATCH KIT
SAMSUNG AFL - SW6004



EC113

DOOR LATCH KIT
BAUER AFL - 550, DAEWOO
AFL - DX550/600, HOOVER
- HW600, MERCURY - 518U,
SAMSUNG - SW6004, UNIVA
- 550



EC127

DOOR LATCH KIT
HOOVER AFL - HW600; KIC
AFL - W600K



G118

INNER DOOR BRACKET KIT
AEG AFL - 800E, 803, 804,
BELLA SL, BELLA 64SL, BELLA
85SL, ELECTRONIC DE LUXE,
REGINA DE LUXE
OEM REF: 645053860



G119

INNER DOOR HINGE
AEG AFL - 800E, 803, 804,
BELLA SL, BELLA 64SL, BELLA
85SL, ELECTRONIC DE LUXE,
REGINA DE LUXE
OEM REF: 645417260



IBE016AD3

DOOR LATCH KIT
INDESIT AFL - W410XZ,
W600W
ORIGINAL PART



KL-3613101210

HOOK, DOOR LATCH
KELVINATOR AFL - KL600FL



LG-3650EN3005A

HANDLE
WD-10480TP, WD-10485TP,
WD-10650TP, WD-80250NP
WD - 10160, WD - 10165
WD-1290FB; WD - 80130F



LG-4027FD3621S

**LATCH ASSEMBLY
COMPLETE WITH BRACKET**
LG DISHWASHER
LD-2040WH



LG-4027FD3621X

LATCH ASSEMBLY
LG DISHWASHER
LD-2050MH, LD-2050SH,
LD-2052SH



Z126

DOOR LATCH KIT
AEG AFL - LAVAMAT 303F,
400F, 502, 800E, 803, 804,
LAVAMAT FE, PE, TE
OEM REF: 645422785



HA101070

HINGE, SPIN LID
DEFY/BAUER TWIN TUB -
DTT130



KD14SS2023K

HANDLE ASSEMBLY
KELVINATOR Dishwasher -
KD14SS



KL-3618200200

PIN, DOOR LATCH
KELVINATOR - KL600FL



LG-4027FD3621F

LATCH ASSEMBLY
LG DISHWASHER
LD-12AS6



LG-4027FD3621L

LATCH ASSEMBLY
LG Dishwasher - LD2050



PN-AD510181

DOOR STRIKER
SPEEDQUEEN tumble dryer - all
models
ORIGINAL PART



DRUMS: INNER, OUTER, PARTS

4819 528 78D62



DRUM ROLLER
WHIRLPOOL tumble dryer -
3LER5434BW1, 3LER5436EQO,
GLE5700XSWO
ORIGINAL PART

4819 532 68533



CENTRE POST GASKET
WHIRLPOOL top loaders - all USA
models
ORIGINAL PART

D27911



DRUM PADDLE
DEFY tumble dryers
DTD MODELS

D2827760100



DRUM BAFFLE
DEFY TUMBLE DRYER
SERIES 600
DAW 317 - 20 / DAW 322 - 26

D28019

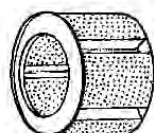

DRUM ASSEMBLY
DEFY tumble dryer - autodry
5: D150, 'DTD' series except
DTD236, DTD237. NLA.
ORIGINAL PART

EC115



INNER DRUM
BAUER AFL - 550, DAEWOO AFL -
DX550/600, HOOVER - HW600,
KIC - W600K, MERCURY- 518U,
SAMSUNG - SW6004, UNIVA - 550
OEM REF: 704000200

KL-421309235891



DRUM BEARING ASSEMBLY
KELVINATOR tumble dryer -
KTD60

PN-AD56285P



**ROLLER, DRUM SP/QN SCREW
SHAFT**
SPEEDQUEEN DRYERS

PN-AD56461



ROLLER SHAFT
SPEEDQUEEN dryers

PN-AD62649P



DRUM ROLLER
SPEEDQUEEN tumble dryer -
HE4930, NE5313
ORIGINAL PART

FANS: BLOWER, PULLEYS



4819 515 28127

BLOWER FAN
KIC tumble dryer - CT411, CT511; WHIRLPOOL - AWG274 - KELVINATOR KTD60
ORIGINAL PART



4819 515 48051

BLOWER WHEEL
WHIRLPOOL tumble dryer - GLE5700XS, 3LER5434, 3LER5436
ORIGINAL PART



D24509

BLOWER FAN
DEFY tumble dryer - autodry 5 series early
11mm Hole
ORIGINAL PART



D28718 / D68488

FAN BLADE
DEFY TUMBLE DRYER
fits D28236 motor
12mm Hole

FILTERS



285868

REPLACEMENT FILTER PLUG
WHIRLPOOL top loaders - all USA models



4819 480 58127

SCREEN FILTER
WHIRLPOOL dryers - GLE5700, 3LHER5434



D23478

FILTER RETAINER
DEFY tumble dryer - autodry 5 : D150, 'DTD' series
ORIGINAL PART



D3611906301

LINT FILTER, NANO
DEFY Top Loaders - DTL125, DTL130



D3611904700

LINT FILTER ASSEMBLY
lint filter ASSEMBLY, DTL125 DTL115 / DTL120 / DTL125 / DTL130 -132

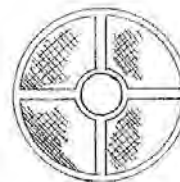

DLMF001

LINT FILTER
DEFY tumble dryer - autodry 5 : D150, NLA.



DY20

SPONGE FILTER
DEFY tumble dryer - autodryer 3.6, autodry 36, autodry 45, sensimatic 45, varidry
OEM REF: 9720033



HA-012

LINT FILTER
twin tub - BAU.TTW9, KELVINATOR KL90



HA10141

LINT FILTER
twin tubs : AIM - ATT5, BAUER - TT800, DEFY twinmaid - DTT130, DTT135, DTT140, DTT141, DTT142, fridgemaster - WA56P, HARWOOD - WA56P, SVASA - WA56P, UNIVA - UT600
ORIGINAL PART



HA20103

LINT FILTER
DEFY - DTT146/148/161/166
ORIGINAL PART



KL-02530618S0107

LINT FILTER
KELVINATOR Lint filter -
KL100TT4/5



KL-301113600608

LINT FILTER
KELVINATOR Twin tub -
KL14TT



KL-3611904700

LINT FILTER ASSEMBLY,
DTL125
DEFY Top loader - DTL125,
DTL130; KELVINATOR -
KL15TL / KL13TL
OEM REF: 008988



KL85TT54K

LINT FILTER
KELVINATOR - KL85TT

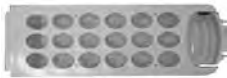

KLL72TT57K

LINT FILTER
KELVINATOR twin tub -
KLL72TT



LG-004

LINT FILTER
LG top loader -
WF7014/5001
OEM REF: 3W50804D



LG-005

LINT FILTER
LG top loader -
WF701/8016T/1001/1011
OEM REF: 5231FA2239K



LG-013

LINT FILTER
WP1100
KELVINATOR T/T
KLL100TT
OEM REF: 5231FW3008C



PN-AD 502140P

LINT FILTER
SPEED QUEEN
EE2007 / AEM477



PN-AD61376P

FIXED MESH FILTER
SPEED QUEEN tumble dryer
- HE4930, NE5313
ORIGINAL PART



S-DC91-10404U

LINT FILTER
SAMSUNG top loader -
SW70X2P
ORIGINAL PART



S-DC91-11250A

LINT FILTER
SAMSUNG twin tub - SE-
W651AX
ORIGINAL PART



TSS12

LINT FILTER
SAMSUNG -
WA1385/75B7/10R3



TSS14

LINT FILTER BOX
SAMSUNG Top loader
:WA7584, WA75B7PTIW,
SW70AIP
OEM REF: DC62-60312E



TSS17

LINT FILTER
SAMSUNG Top loader -
SW70X2P, SW-H105P
OEM REF: DC91-10404U
SWIOKISP1W



TSS18 / S-DC91-10404V

LINT FILTER
SAMSUNG top loaders -
SW5AC1P, ROSSBY 5
OEM REF: DC91-10403A



TSS19

LINT FILTER
SAMSUNG twin tub -
WT10J7, WT13J7, WT16J7,
WT80J7, WT80S2P
OEM REF: DC61-10077D

GEARBOXES: COMPLETE, PARTS



4812 101 00304

RING RETAINING
WHIRLPOOL top loaders - 3LA5800XS,
3LA5580XS, 3XLA87W72,
3XLA87W92, 3LSR6233
ALT: 90368



4812 522 18003

GEARBOX ASSEMBLY
WHIRLPOOL top load-
er - 3LHE5123HW,
3LHE5123GW, WWF22ABY-
WF, WWQ24BBYWF
ORIGINAL PART



4812 278 58002

ACTUATOR 20V 50/60 Hz
WHIRLPOOL top loaders -
WWF22, WWQ24
ALT: 32.6006.82.2



4819 002 85790

BAND AND CLUTCH LINING
WHIRLPOOL top loader - all
USA models
ALT: 285790



4819 310 38725

NEUTRAL ASSEMBLY
WHIRLPOOL top loader - all
USA models
ORIGINAL PART



4819 466 69832

SHAFT SEAL
WHIRLPOOL top loader - all USA
models
ALT: 91939



4819 466 69834

SEAL, GEARCASE COVER
WHIRLPOOL top loader -
most USA models



4819 466 88948

DRIVE BLOCK
WHIRLPOOL top loader - all
USA models
ORIGINAL PART



4819 522 28008

TRANSMISSION ASSEMBLY
WHIRLPOOL top loader -
3LA5800XSWPO, 3LA5580X-
SWO, 3XLA87W72BWO,
3XLA87W92BQO, 3LSC8255EQO,
3LSR6233EQO
ALT: 3360632 / 3363395



4819 522 38016

GEAR, SPIN
WHIRLPOOL top loaders -
3LA5800XS, 3LA5580XS,
3XLA87W72, 3XLA87W92,
3LSR6233



4819 535 98415

BRAKE AND DRIVE TUBE
WHIRLPOOL top loader - all USA
models
ALT: 285792



4819 690 18152

**CLUTCH ASSEMBLY - COM-
PLETE**
WHIRLPOOL top loader - all
USA models
ALT: 285785



D3617310400

GEAR MECHANISM
KELVINATOR top loaders -
KL10/13/15TL
DEFY T / LOADERS
DTL115 / 120 / 125 / 129 /
130



D66884

GEARBOX ASSEMBLY
DEFY 13kg T/T
DTT 164 / 165



E140

CLUTCH SOLENOID
to fit KELVINATOR top loader
- U1750/61, also suitable
for use on kic top loader -
SWT800/WSA900, BAUER
top loader - TLS800A



HA-006

GEARBOX ASSEMBLY
BAUER - TTW9
DEFY T/T
DTT146 / 152 / 161
KELVINATOR - KL100TT4/5
K613TT1/2



HA11107

GEARBOX ASSEMBLY
twin tubs: AIM - ATT5, BAUER - TT800,
DEFY twinmaid - DTT130, DTT135,
DTT140, DTT141, DTT142, fridgemaster
- WA56P, HARWOOD - WA56P, SVASA -
WA56P, UNIVA - UT600



HS101044

GEARBOX ASSEMBLY
HISENSE twin tubs - XPB60 -
2000S/SA, XPB80-2000S/SN
NU-TEC - NTT5500 / 6500



KL-301213000804

GEARBOX ASSEMBLY
KELVINATOR twin tub -
KL14TT



KL-3617310510

GEARBOX ASSEMBLY
KELVINATOR top loader -
KL80TL
DEFY T / LOADER
DTL 128



KL80TT39K

**GEARBOX KELV.KL100TT2/
KL72TT**
KELVINATOR twin tub -
KLL80TT



KLL13TT-02

GEARBOX
KELVINATOR twin tub -
KLL13TT



LG-003

GEARBOX ASSEMBLY
LG twin tub - WP7550/8050
OEM REF: 2W06286B



LG-006

GEARBOX ASSEMBLY
DAEWOO twin tub - DW1090,
LG TWIN TUBS - WP994PT /
WP8240PT - WP9800 ROUND
SHAFT



LG-012

GEARBOX ASSEMBLY
WP8200QS
LG TWIN TUB
WP11000S
WP1300 QS / P1160RWP



LG-028

CLUTCH ASSEMBLY
LG top loaders
T8011TD, WF-8071TTP, WF-
T7050TP
ALT: LG-4265EA1006C



LG-030

GEARBOX ASSEMBLY
LG top loaders - WFT1330TP,
WFT9230



LG-4265EA1006C

CLUTCH ASSEMBLY
LG top loaders
T8011TD, WF-8071TTP, WF-
T7050TP



PN-AB36107P

GEARBOX POST BEARING
SPEEDQUEEN top loader - all
models
ORIGINAL PART



PN-AB28114

GEARBOX SEAL
SPEEDQUEEN top loader - all
models
ORIGINAL PART

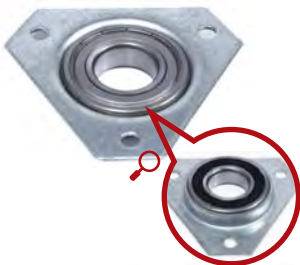

PN-AB27182

**UPPER HOUSING AND
BEARING**
SPEEDQUEEN top loader - all
models
ORIGINAL PART



PN-AB27243P

**GEARCASE OIL 24 Oz (ONE
FILL)**
SPEEDQUEEN and
WHIRLPOOL top loaders
ORIGINAL PART



PN-AB31526

RACK, GEARBOX
SPEEDQUEEN top loaders



PN-AB34526

TRANSMISSION ASSEMBLY
SPEEDQUEEN top loader
- AWM270, AWM372,
AWM373, EA2011, WA3000,
RWM274, RWM373
ORIGINAL PART



PN-AB356P3

HUB AND SEAL REPAIR KIT
SPEEDQUEEN top loader -
HA4011, HA4511
ORIGINAL PART



PN-AB36570

GEARBOX OUTPUT (UPPER) SHAFT
SPEEDQUEEN top loader -
AWM270, AWM351, AWM352,
AWM372, AWM373, NA3311,
RWM274, RWM373, WA4981
ORIGINAL PART



PN-AB38826P

TRANSMISSION ASSEMBLY
SPEEDQUEEN top loader -
LWS11A, LWS21A
ORIGINAL PART



PN-AB495P3

HUB AND SEAL REPAIR KIT
SPEEDQUEEN top loader -
AWM270, AWM351, AWM352,
AWM372, AWM373, EA1211,
NA3311, WA4981
ORIGINAL PART



PN-AB766P3

HUB AND SEAL REPAIR KIT
SPEEDQUEEN LW S11/21



PH12

GEARBOX ASSEMBLY
to fit DAEWOO/KIC twin tub -
TT7000, TT7100; HOOVER
Twin tub - HT6000, HT6500



TEC16

GEARBOX ASSEMBLY
CONTI/TELEFUNKEN/SUN-
BEAM twin tub - TTT850



TSS21

GEARBOX ASSEMBLY
SAMSUNG twin tub:
WT13J7P, WT10J7, WT8052P



TSS22

GEARBOX ASSEMBLY
SAMSUNG twin tub:
WT80J7P, PREMIER : XPB50-
95
ALT: S-DC97-01067A

HEATING ELEMENTS



4812 310 28307

HEATING ELEMENT
WHIRLPOOL AW2121

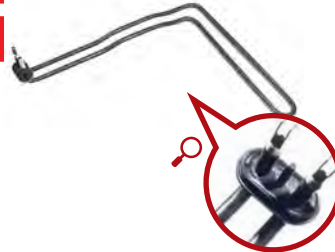

A273

HEATER ELEMENT - 2200W
INDESIT dishwasher -
D3300WI/U, D4000,
DG5000, D3050W1
OEM REF: RIM009DA1



BS16

HEATER ELEMENT
BOSCH AFL:
WAA20111EE/01,
WAA28161GB/09,
WAE16122IT/01,
WAE16160PL/03
OEM REF: 265961



BS18

DRYER ELEMENT
BOSCH TUMBLE DRYER
WTA 4000 / BY01
OEM REF: 4498557



D188150100

ELEMENT, THRU FLOW
KELVINATOR dishwasher -
KD12DW/W
DEFY DISHWASHER
DDW147-152
DDW 164/165/167



DY06

HEATER ELEMENT
DEFY AFL - all automaids;
INDESIT washer/dryer - 525,
526; PHILIPS AFL - most
local models
OEM REF: 020214



DY16

DRYER ELEMENT - 2150W
DEFY tumble dryer -
autodrier 3.6, autodry 36,
autodry 45, sensimatic 45,
varidry; INDESIT washer/
dryer - 525, 526
OEM REF: 023885



DY18

DRYER ELEMENT
DEFY TUMBLE DRYER -
DTD236/7, DTD252



DY103

HEATER ELEMENT
DEFY dishwasher -
DDW114/5/6/7/8/9



E119

DRYER SPIRAL ELEMENT
DEFY tumble dryer - autodry
5: D150, 'DTD' series
except DTD236 & DTD237;
KELVINATOR tumble dryer -
N130, N140, J2500, J2501,
J2502, J2503, T50WF
OEM REF: 023371

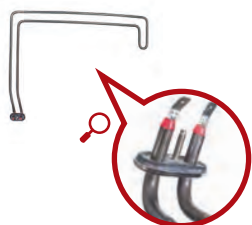

EC130

HEATER ELEMENT
DAEWOO dishwasher
- DD12, KIC d/washer -
D4800, D5000H



KL-KL750CM-104

HEATING ELEMENT - DOUBLE
KELVINATOR washer/dryer -
KL75CM



PN-AD61929

DRYER ELEMENT AND
THERMOSTAT
SPEEDQUEEN tumble dryer -
HE4930, NE5313
ORIGINAL PART



WPD001

ELEMENT
KELVINATOR - KD12DW45K
KD12DW00K
KD12DW, WESTPOINT -
WQP8

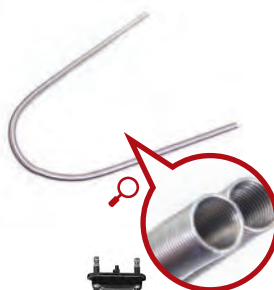

HTD01

DRYER ELEMENT
HOOVER tumble dryer - all
models
OEM REF: 647409



LG-AEG33121503

HEATER ASSEMBLY
AFL - WD10160/10165/
10485/10650/10655/
12331/12336



S-DC47-00005D

ELEMENT 2000W
SAMSUNG dryer - DV500J,
DV665JW
ORIGINAL PART



WTD01

DRYER ELEMENT
KIC tumble dryer - CT411,
CT511; WHIRLPOOL tumble
dryer - AWG274; KIC tumble
dryer - CT311
KELVINATOR T/D
OEM REF: 4213 092 05741

HOSE FITTING AND PLUMBING ACCESSORIES



A130

SUPERGLUE - 3g
super strength adhesive



A140

PTFE TAPE - 10m
10mm plumbing tape



A143

FILL HOSE WASHER
suitable with 3/4" fill hose ends



A1380

FILL HOSE FILTER
suitable with 3/4" fill hose
ends



HC100

DRAIN HOSE CONNECTOR
20mm x 20mm



HC103

FILL HOSE CONNECTOR -
3/4"
10mm angled incl. washer



HC104
FILL HOSE CONNECTOR - 3/4"
 10mm straight incl. washer



HC105
DRAIN HOSE CONNECTOR
 15mm x 15mm



HC107
DRAIN HOSE CONNECTOR
 23mm x 23mm



HC108
FILL HOSE JOINER CONNECTOR
 3/4" x 3/4"



HC109
"Y" PIECE FILL HOSE CONNECTOR
 3/4" male to 2 x 3/4" female



HC110
SWIVEL TAP CONVERTER - METAL
 fine thread to 3/4"



HC111
TAP CONVERTER - METAL
 5/8" to 3/4"



HC112
TAP CONVERTER - METAL
 1/2" to 3/4"



HC114
TAP CONVERTER - METAL
 5/8" to 3/4"



HC115
TAP CONVERTER - METAL
 1/2" to 3/4"



HC124
PLAIN TAP CONVERTER
 to convert 1/2" and 5/8" plain taps to 3/4" thread



HC132
3-IN-1 CONVERTER PIECE - PLASTIC
 3/4" to 3/4" outside thread, 5/8" and 1/2" inside thread



PLIOBOND
A131
 50ml - GOODYEAR brand
A132
 100ml - GOODYEAR brand



SNPT
PLUG TOP
 3PIN ISAPLUG TOP



SNPT-R
RUBBER PLUG TOP
 3 PIN 16AMP



SILICONE
SILICONE 280ml
 DIFFERENT COLOURS
 BLACK , CLEAR, GREY, WHITE.



INSULATION TAPE

HIGH QUALITY NITTO TAPE No.21 -
0.2mm x 20m ROLL

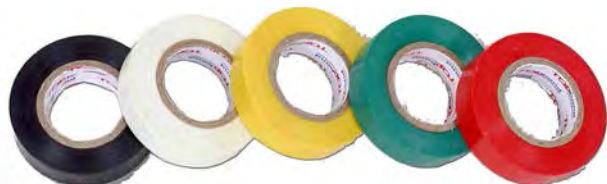

Available Colors: 
Codes: SITB, SITB2, SITG, SITR, SITW, SITY

INSULATION TAPE

HIGH QUALITY NITTO TAPE No.13 -
0.13mm x 20m ROLL



Available Colors: 
Codes: SITBA, SITB2A, SITGA, SITRA, SITWA, SITYA



LG-3911JA3001E

INSTALLATION PACKAGE
ASSEMBLY
universal application



LP-WP0001/2

TAP CONVERTER - PLASTIC
3/4" S.A thread to American
thread



LP-WP0001/3

TAP CONVERTER - BRASS
3/4" S.A thread to American
thread



PN-AB20290

WASHER, RUBBER SP/QUEEN
WASHERS
SPEEDQUEEN top loaders

HOSES EXTERNAL



4812 530 28737

DRAIN HOSE ASSEMBLY
WP072
WHIRLPOOL D/W
ADP751



4819 281 74

CRUSHPROOF DRAIN HOSE
- 1,5m
WHIRLPOOL top loader - all
models
ORIGINAL PART



D1853200200

DRAIN HOSE
DEFY Dishwasher
D/W DWW130



FHM

HIGH PRESSURE HOSE - PER
METRE
10mm I.D. High pressure
hose suitable for hot and
cold water



LG-5215ED3001B

DRAIN HOSE ASSEMBLY
LG dishwasher - LD-2040WH, LD-2050MH, LD-2060LH, LD-2120SH



PN-AB28293

RUBBER DRAIN HOSE
SPEEDQUEEN top loader - all models
ORIGINAL PART



WMH06

FILL HOSE - 1,2m
suitable with all makes of twin tubs

CRUSHPROOF DRAIN HOSES

CP1

1,5M - 18mm END + 22mm END DRAIN HOSE WITH HOOK

CP2

2M - 18mm END + 22mm END DRAIN HOSE WITH HOOK

CP3

3M - 18mm END + 22mm END DRAIN HOSE WITH HOOK

CP4

2M - 18mm END + 30mm END DRAIN HOSE WITH HOOK

CP5

2M - 18mm END + 90 DEG 22mm END DRAIN HOSE WITH HOOK

CP2



CP4



CP5

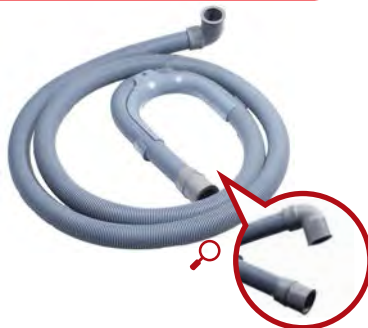



HOSES EXTERNAL

FH100B

1 METRE STRAIGHT END + 90 DEG END - 3/4"

FH150A

1,5M STRAIGHT END + AMERICAN THREAD STRAIGHT END - 3/4"

FH150B

1,5M STRAIGHT END + 90 DEG END - 3/4"

FH150S

1,5M STRAIGHT END + STRAIGHT END - 3/4"

FH200A

2M STRAIGHT END + AMERICAN THREAD STRAIGHT END - 3/4"

FH200B

2M STRAIGHT END + 90 DEG END - 3/4"

FH200B-B

2M 90 DEG END + 90 DEG END - 3/4"

FH200S

2M STRAIGHT END + STRAIGHT END - 3/4"

FH250A

2,5M STRAIGHT END + AMERICAN THREAD STRAIGHT END - 3/4"

FH250B

2,5M STRAIGHT END + 90 DEG END - 3/4"

FH250S

2,5M STRAIGHT END + STRAIGHT END - 3/4"

FH300A

3M STRAIGHT END + AMERICAN THREAD STRAIGHT END - 3/4"

FH300B

3M STRAIGHT END + 90 DEG END - 3/4"

FH300S

3M STRAIGHT END + STRAIGHT END - 3/4"

FH350B

3,5M STRAIGHT END + 90DEG - 3/4"

FH350S

3,5M STRAIGHT END + STRAIGHT END - 3/4"

FH400B

4M STRAIGHT END + 90 DEG END - 3/4"



HOSES INTERNAL



3348552

HOSE - PUMP TO DRAIN CONNECTOR
WHIRLPOOL top loaders - 3LA5800XS, 3LA5580XS



4819 039 50340

PUMP TO TUB HOSE
WHIRLPOOL top loaders - 3LA5800, 3LA5580, 3XLA87W72
ALT: 285871



4819 530 28889

VACUUM BREAK HOSE
WHIRLPOOL top loaders - all USA models
ALT: 62662 / 3357328



A261

PUMP HOSE
INDESIT AFL - LIMPIA series, W400 series, W600 series
OEM REF: GFF027AA1



A272

PUMP HOSE
INDESIT AFL - WN461WO, WN657WF/Z, WN663WO
OEM REF: 108874



D22859

SOAP HOSE
DEFY automaid DA455



D28688

SOAP HOSE
DEFY AFL - DAW280/DAW300



D3613212120

HOSE, TUB TO PUMP
DEFY top loader - DTL115/DTL120, KELVINATOR - KL10TL, KL15TL



D62681

SUMP HOSE
DEFY AFL - DAW350 (LATE)



DY35

PRESSURE HOSE
DEFY AFL - DA455, 'DAW' series (MK4)



DY57

SOAP HOSE
DEFY AFL - DA504, DA505, DA508, DA656
OEM REF: 020095



G102

SOAP HOSE
AEG AFL - 500 series, 600 series, 800E, 803, 804, BELLA series, ELECTRONIC, ELECTRONIC DE LUXE
OEM REF: 645050950



H07

DRAIN VALVE TO PUMP HOSE
DEFY twin tub - ESE550SWP; HITACHI twin tub - most models; suitable with many other makes of twin tubs



LG-4738FR1145A

BELLOWS HOSE
LG AFL - WD-10130, WD-10160, WD-10165, WD-1290, WD-1295, WD-80130, WD-8050



LG-4W07137A

HOSE D DRAIN WP1100QS
P1160/1360/1400/1860, 1100/1300/8200/9000 /9916



LG-5214EN3040A

HOSE,PUMP
LG - T8011TDFP, WF-8071TTP, WF-7014PP, WF-7050TP



LG-5214FA3737C

HOSE,PUMP
LG - WF-T1022TP



N18

PUMP SUCTION HOSE
NATIONAL twin tub - T350, T450, T550
OEM REF: J800034



PN-AB35766

ELBOW, DRAIN HOSE
SPEEDQUEEN top loaders - most models



S-DC62-00092A

HOSE TUB TO PUMP
SAMSUNG AFL - SW85ASP



S-DC62-10291B

PUMP HOSE
LG AFL - WSL1100A



S-DC62-10293A

PUMP TO DRAIN HOSE
SAMSUNG TWIN TUB



WMH106

UNIVERSAL PRESSURE SWITCH HOSE - PER METRE
5mm I.D - suitable with most AFL'S and dishwashers

INTERLOCK SWITCHES



4819 690 18108

DOOR INTERLOCK SWITCH
PHILIPS AFL - AWB006,
AWB010, AWB906, AWB912,
AWG752; WHIRLPOOL AFL -
AWG372, AWG376, AWL352,
AWM807, AWM815, AWM875
ORIGINAL PART



A231

DOOR INTERLOCK SWITCH
INDESIT AFL - 090, 091, 092,
097, 099, 2092, 2093, 2094,
2095, 2097, W400 series,
W600 series, WN461WO,
WN657WF, WN663WO,
WG521, WG623, WG635
OEM REF: 011140



D2805310400

DOOR INTERLOCK
DEFY AFL - DAW351



DY26

DOOR INTERLOCK SWITCH
DEFY AFL - DA455, DA504,
DA505, DA508, DA656,
'DAW' series (MK4), DEFY
washer/dryer - DW506
OEM REF: 027832



G130

DOOR INTERLOCK SWITCH
AEG AFL - 500 series late



KL-3619047100

DOOR INTERLOCK SWITCH
LG AFL - WD10130F,
WD10160F, WD10165F,
WD12150FB, WD80100,
WD80130, KELVINATOR -
KL600FL, KL750CM
ORIGINAL PART



KM085

DOOR INTERLOCK SWITCH
ARISTON AFL - AR410, AR444,
AR616, LB150, LB410, LB412;
HOOVER AFL - A2218, A2404,
A2428U, A2460U; KELVINATOR
AFL - A205, A206, A2005,
A2006, A5500, A5501, A5502,
A5506, A5513, A5600, A5601,
WAF50NNR, WAF60NNR



LG-6601ER1005A

DOOR INTERLOCK SWITCH
LG AFL - WD10130F,
WD10160F, WD10165F,
WD12150FB, WD80100,
WD80130
ORIGINAL PART



S-DC64-00120E

DOOR INTERLOCK SWITCH
SAMSUNG AFL - B1215J,
B1415J, WF6702N7S,
WF676N7
ORIGINAL PART



S-DC64-00653A

DOOR INTERLOCK SWITCH
SAMSUNG AFL - WF7600,
WF-J125NR
ORIGINAL PART



KNOBS



480191100574

TIMER KNOB - BLACK
WHIRLPOOL top loader -
3XLA87W72BWO
ORIGINAL PART



D66798

TIMER KNOB
DEFY - DAW310, DTD252-4
ALT: D63360



PN-AB33688

SELECTOR KNOB
SPEEDQUEEN top loader -
AWM270, AWM373
ORIGINAL PART

LIDS



HA10111

SPIN LID
twin tubs : DEFY twinmaid
- DTT130/DTT135, DTT140,
DTT142
ORIGINAL PART



HA20206

WASH LID
DEFY - DTT146/148
BAUER



A250

TIMER KNOB
INDESIT dishwasher - 111,
114, LS12, LS18, LS120, P12,
P18
OEM REF: ALP003AA1



PN-AB31281

TIMER KNOB
SPEEDQUEEN top loader -
NA3311
ORIGINAL PART



PN-AB33897

TIMER KNOB - BLACK
SPEEDQUEEN top loader -
AWM351, AWM352
ORIGINAL PART



HA20203

INNER SPIN COVER
DEFY - DTT146/148
BAUER



LG-3523EA1059A

LID ASSEMBLY
LG Toploader
WF-T1391TP

MISCELLANEOUS DISHWASHERS



041017

UPPER SPRAY ARM PIPE
INDESIT dishwasher -
D4000WZ



4819 528 78108

UPPER BASKET WHEEL
WHIRLPOOL dishwashers -
ADP751, ADP755, KD6000



4819 528 78104

WHEEL, BASKET UPPER(SET)
WHIRLPOOL dishwashers -
KD6000, ADP751



A139

WASH BLADE SUPPORT
INDESIT dishwasher -
DG6100
OEM REF: 075111



A249

BASKET SLIDE - 6 PIECES
INDESIT dishwasher - 111, 114, 115
116, 2111, 2114, 2115, 2116, D310
D340, D350, D360, LS12, LS18,
LS120, P12, P18
OEM REF: IPA004AA2



A254

CUTLERY BASKET
suitable with most makes of
dishwashers
OEM REF: EGI003BA2



KD12DW122K

GASKET, TANK
KELVINATOR dishwasher -
KD12DW



KL-1001

FEEDER PIPE
KELVINATOR dishwasher
- KD12DW, WESTPOINT -
WQP12



KL-1004

NUT, FEEDER PIPE
KELVINATOR dishwasher
- KD12DW, KD12DW2SS;
WESTPOINT - WQP12



KL-1054

AIR BREATHER ASSEMBLY.
KELVINATOR dishwasher -
KD12, KD14



LG-3751ED1001K

RACK ASSEMBLY
LG Dishwasher
LD-2040WH



LG-4580ED3001A

ROLLER, 2162 DISH WASHER
LD-12/2040/2050/2060
/2120/2162



LG-4581DD3002A

ROLLER ASSEMBLY
LG dishwasher - D1417, LD-
2120



LG-4581DD3003A

BASKET WHEEL
LG dishwasher - LD2130WH



LG-5005ED2003B

CUTLERY BASKET
most LG late models
ALSO FITS MOST
KELVINATOR DISHWASHERS



LG-5249FD1168C

TIMER KNOB
DEFY AFL - DAW242/270



MISCELLANEOUS WASHING MACHINES



4819 466 98643

BREAK VACUUM
WHIRLPOOL top loader -
most USA models



KL-PI288S-0210

DRAIN VALVE ASSEMBLY
KLL13TT
KELVINATOR twin tub -
KLL13TT



KL-04112000STYK

BRAKE PLATE ASSEMBLY
KELVINATOR twin tub -
KL100TT4, KL100TT5



KL100TT2-24K

BRAKE CABLE
KELVINATOR twin tub -
KL100TT2/3/M/KLL13TT



KL-301102300009

BRAKE PLATE ASSEMBLY
KELVINATOR twin tub -
KL14TT



KL80TT20K

BRAKE CABLE ASSEMBLY
KLL72/KL80TT
KELVINATOR twin tub -
KLL80TT



LG-4W07416A

'Q' SPRING
LG twin tub - WP8100P
ORIGINAL PART



PN-AB38505P

BRAKE PLATE ASSEMBLY
SPEEDQUEEN top loader - all
models
ORIGINAL PART



PN-AB548P3

BRAKE PAD KIT
SPEEDQUEEN top loader - all
models except LWS11A &
LWS21A
ORIGINAL PART



PN-AB735P3

BRAKE PAD KIT
RAYTHEON / SPEEDQUEEN
top loader - LWS11A,
LWS21A
ORIGINAL PART



S-DA26-00003A

TRANSFORMER
SAMSUNG top loaders -
RL38E, RL39, SR-L38, SR-L41

▶ **MOTORS: CIRCULATING, COMPLETE PARTS**



▶ **041105**

CIRCULATING PUMP HOUSING
INDESIT dishwasher -
D4000WZ
ORIGINAL PART



▶ **041106**

CIRCULATING PUMP MOTOR
INDESIT dishwasher -
D4000WZ
ORIGINAL PART



▶ **450RC80000**

WASH MOTOR
DAEWOO/KIC twin tub -
TT524P
ORIGINAL PART



▶ **4812 360 18014**

CIRCULATING PUMP HOUSING
WHIRLPOOL dishwasher -
ADP256, ADP556, ADP566,
ADG635, ADP751
ORIGINAL PART



▶ **4812 361 58007**

CIRCULATING PUMP
COMPLETE
WHIRLPOOL dishwasher -
ADP256, ADP556, ADP566,
ADG635, ADP751
ORIGINAL PART



▶ **4812 361 58434**

MOTOR AND SPRAY PUMP
WHIRLPOOL dishwasher -
ADP4300



▶ **4812 532 68088**

PLASTIC SLEEVE
for use on motor 3950297
MODELS: 3LSR6233, 3LSR6233



▶ **4819 039 50297**

MOTOR, MAIN DRIVE
WHIRLPOOL top loaders - all
USA models



▶ **4819 215 28035**

MOTOR COUPLING KIT
WHIRLPOOL top loader - all
USA models
ORIGINAL PART



▶ **4819 276 18205**

MOTOR SWITCH
WHIRLPOOL top loader - all
USA models
ORIGINAL PART



▶ **4819 361 58124**

MAIN MOTOR
WHIRLPOOL tumble
dryer - 3LER5434BW1,
3LER5436EQO,
GLE5700XSWO
ORIGINAL PART



▶ **A161**

PUMP HOUSING
INDESIT dishwasher -
DG6100
OEM REF: 055005



▶ **A197**

CIRCULATING PUMP SEAL KIT
DEFY dishwasher - dishmaid: MKI,
MKII, MKIII, A, B, C, 3126, 3127,
3128; INDESIT dishwasher - 111,
114, 115, 116, 2111, 2114, 2115,
2116, D310, D340, D350, D360,
LS12, LS18, LS120, P12, P18
OEM REF: GKH005AA1



▶ **D1891000400**

CIRCULATING PUMP
DEFY dishwasher - DDW12,
DDW126, DDW130-
131, DDW140-
142, DDW164-165



D27445A

MAIN MOTOR
DEFY AFL - automaid: MK1, AA
thru AH, DA455, DA504, DA505,
'DTD' series STD (2 speed
models only)
OEM REF: 027445



D68265

MAIN MOTOR
DEFY tumble dryer - autodry
5: D150, 'DTD' series
excluding DTD260
ORIGINAL PART



HA10613

SPIN MOTOR
CONTI/TELEFUNKEN/
SUNBEAM twin tub -
TTT850; DEFY DTT130/5,
fridgemaster - WA56P;
HARWOOD - WA56P



EC132

IMPELLOR AND SEAL KIT
HOOVER/INDESIT dishwasher
- D4800, D5000; DAEWOO
dishwasher - DD12



HA22004

SPIN MOTOR
DEFY - DTT146/148



HX665

WASH MOTOR
HOOVER twin tub - HX606



KD12DW53K-VLV

WASH MOTOR WITH VALVE
KELVINATOR - KD12DW/W



D29509

**CIRCULATING PUMP
HOUSING**
DEFY dishwasher - DDW11



DW3618947100

SPIN MOTOR
BAUER - TTW4 (late models);
DAEWOO / PHILIPS twin tubs



HA10614

WASH MOTOR
twin tubs : AIM - ATT5; BAUER
- TT800; DEFY twinmaid -
DTT130, DTT135, DTT140,
DTT141, DTT142, fridgemaster
- WA56P; HARWOOD - WA56P,
SVASA - WA56P; UNIVA - UT600



HA22003

WASH MOTOR
DEFY - DTT146/148, DTT164
/ DTT165



HA22004-3

SPIN MOTOR
DEFY twin tub - DTT152 /
153 / 154 / 156 / 161 / 162
/ 163 / 164 / 171
OEM REF: 66849



KD12DW53K

MOTOR . KD12/ W/PNT
WQP12
KELVINATOR - KD12;
WESTPOINT WQP12



KL-00330504076

WASH MOTOR
KELVINATOR KL90TT; BAUER -
TTW9



KL-100TT2-04K

MOTOR, WASH-220W
KELVINATOR twin tub -
KLL100TT2



KL-100TT2-13K

BUSH, SPIN MTR COUPLER
KL100TT2
KELVINATOR twin tub -
KLL100TT2



KL-100TT2-27K

MOTOR, SPIN KELV.
KL100TT2/3/M
KELVINATOR twin tub -
KLL100TT2



KL-168930341

MOTOR, DRAIN SYNCHRONOUS
KELVINATOR T/L - KLL72TL



KL-302451490009

SPIN MOTOR - 80W
KELVINATOR twin tub -
KL14TT



KL-3618960210

MOTOR ASSEMBLY
KELVINATOR top loader -
KL80TL



KL-3964311310

MAIN MOTOR
KELVINATOR top loader -
KL10TL



KL-3964510430

MOTOR
KELVINATOR top loader -
KL15TL



KLL13TT-03

SPIN MOTOR
KELVINATOR twin tub - KLL13TT



KLL72TT10K

BUSH, MOTOR COUPLING
KELVINATOR twin tub -
KLL72TT, 80TT, 100TT



LG-017

MOTOR, DRAIN
LG top loaders - WFT1001TP,
WFT1050, WFT8016TP
OEM REF: 5250FA1731E



LG-020

MOTOR, SPIN
Twin tub: WP1100, WP-1300
ALT: LG-4681FW1145K /
EAU35128601



LG-4681EL1003C

MOTOR ASSEMBLY - WM
tumble dryer TD-V75120E,
TD-75125



LG-4681EN1010C

MOTOR ASSEMBLY
LG AFL - WD-80100TP, WD-
80490



LG-4681ER1003A

MOTOR ASSEMBLY - WM
LG AFL - WD-12150, WD-12235, WD1290, WD1295



LG-4681FR1194D

MOTOR ASSEMBLY
AFL - WD-10130F, WD-1021WF



LG-5859DD9001A

CIRCULATING PUMP MOTOR
LG dishwasher - LD-2050SH



LG-EAU31357603

MOTOR AC
twin tub: P1160RWP, P1360RWP, P1400ROP



PN-AB35030

MAIN MOTOR
SPEEDQUEEN AWM27



PN-AB835P3

MAIN MOTOR
SPEEDQUEEN top loader - LWS11A, LWS21A
ORIGINAL PART



PN-AD501212

MAIN MOTOR
SPEEDQUEEN tumble dryer - AEM477, EE2107, REM477
ORIGINAL PART



S-DC31-10022N

SPIN MOTOR
SAMSUNG twin tub - SWT90B1P
ORIGINAL PART



TF850-024

SPIN MOTOR
TELEFUNKEN twin tub - TTT850



TSS13

SPIN MOTOR
SAMSUNG - WT1052
OEM REF: DC31-10022T



TSS15

MOTOR, SYNCHRONOUS DRAIN
SAMSUNG top loader: WA80U3, WT80S2P
OEM REF: DC31-20014A

N24

SPIN MOTOR

HOOVER twin tub - HT4500, HT6000, HT6500, HX404, HX606; NATIONAL twin tub - T600, T2600, T2601, T2601/1; SAMSUNG/KIC - twin tub - SW401, SW420, SW600, SW620, SW650, TT7000, TT7100; TOSHIBA twin tubs - most models; LG twin tub - WPB7550
NATIONAL REF: J810078



MOUNTS: CASTORS, FEET, PEDESTALS



4819 462 48269

LEVELLING FOOT
WHIRLPOOL top loaders - all USA models
ALT: 389102



A173

ADJUSTABLE FOOT - 8mm THREAD
INDESIT AFL - all models
OEM REF: IPE005AA2



A174

ADJUSTABLE FOOT - 10mm THREAD
DEFY AFL - all models; also suitable with other makes of AFL'S
OEM REF: 0226240



HA20701

MOTOR DAMPER
DEFY twin tub - DTT160, DTT161



KL-00330014011

MOTOR DAMPER
KELVINATOR twin tub - KL72TT



PN-AB34318

PLASTIC FOOT COVER
Suitable with most American top loaders



▼ PRESSURE SWITCHES



▼ 4812 761 8284

ADJUSTABLE PRESSURE SWITCH
WHIRLPOOL top loader - 3LSR6233EQ1, 3XLSQ7533JQ
ALT: 3366848



▼ B110

DOUBLE PRESSURE SWITCH - 6 CONTACT
Universal application - suitable with most AFL'S with dual water system



▼ D28572

SINGLE LEVEL PRESSURE SWITCH - 4 CONTACT
DEFY AFL - DAW285
ORIGINAL PART



▼ D3614801111

PRESSURE SWITCH
DEFY DTL 132



▼ KL-00216000049404

PRESSURE SWITCH F/LOAD
KELVINATOR automatic front loaders



▼ KL-171020161

PRESSURE SWITCH
KELVINATOR top loader - KL72TL
ORIGINAL PART



▼ KL-3614802303

PRESSURE SWITCH
KELVINATOR top loader - KL13TL



▼ B109

SINGLE PRESSURE SWITCH - 3 CONTACT
Universal application - suitable with most AFL'S with single water level system



▼ D26294

DOUBLE PRESSURE SWITCH - 7 CONTACT
DEFY AFL - DAW265 (MK4)
ORIGINAL PART



▼ D2801560700

PRESSURE SWITCH
DEFY AFL - DAW350/6



▼ KL-00216000000300

PRESSURE SWITCH - DOUBLE LVL
KELVINATOR AFL - KL60FLM
ORIGINAL PART



▼ KL-1117

PRESSURE SWITCH HOSE ASSEMBLY.
KELVINATOR dishwasher - KD12, KD14
ORIGINAL PART



▼ KL-3614802301

PRESSURE SWITCH
KELVINATOR top loader - KL15TL



▼ KL-KL750CM-13

PRESSURE SWITCH
KELVINATOR AFL - KL750CM



LG-025
PRESSURE SENSOR
 LG top loader - WF-T7030TP
 OEM REF: 6501EA1001C



LG - 6601EN100SA
PRESSURE SENSOR
 LG TOP LOADER
 WD-80250TP, WD - 80264NP



LG-6600FA1704P
SENSOR SWITCH ASSEMBLY.
 LG top loader - WF-T1001T



PN-AB39023
ADJUSTABLE PRESSURE SWITCH
 SPEEDQUEEN top loader - LWS11A, LWS21A
ORIGINAL PART



PN-AB39035
ADJUSTABLE PRESSURE SWITCH
 SPEEDQUEEN top loader - AWM351, AWM352, HA4011
ORIGINAL PART



S-DC32-30006M
PRESSURE SENSOR
 SAMSUNG top loader - ROSSBY 5
ORIGINAL PART

PULLEYS: FAN, PULSATOR, MOTOR



4819 528 88085
IDLER JOCKEY PULLEY
 WHIRLPOOL tumble dryer - 3LER5434BW1, 3LER5436EQO, GLE5700XSWO
ORIGINAL PART



4819 528 88119
DRUM PULLEY
 WHIRLPOOL AFL - AWL352, FL243
ORIGINAL PART



D24532
JOCKEY PULLEY
 DEFY tumble dryer - autody 5



D26382
IDLER JOCKEY PULLEY SHAFT
 DEFY tumble dryer - autody 5: D150, 'DTD' series
ORIGINAL PART



D28017
PULLEY
 DEFY tumble dryer - DTD236/DTD237



DY13
DRUM PULLEY
 DEFY AFL - automaid MKI, AA thru AH, DA455, DA504, DA505, DA508, DA656, 'DAW' series (MK4); DEFY washer/dryer - kombomaid: MKI, MKII, DW506



HTD16

IDLER JOCKEY PULLEY

HOOVER tumble dryer - D6008, D6056, D6108, D6110, D6128, D6130, D6148, D6154, D6190, D6200, D6202, D6208, D6296, D6298, D6430, D6500, D6502, D6A08, D6W30 OEM REF: 647354



KL-100TT2-07K

MOTOR PULLEY

KELVINATOR twin tub - KL100TT2, KL100TT3, KL100TTM



KL-100TT44K

MOTOR PULLEY

KELVINATOR twin tub - KLL100TT/4/5



KL-302950600040

WASH MOTOR PULLEY

KELVINATOR twin tub - KL14TT



KL-3618401490

MOTOR PULLEY

KELVINATOR top loader - KL80TL



KL-3618433201

PULLEY DRUM

KELVINATOR AFL - KL600FL



KL-PI288S-047

FAN PULLEY, MOTOR KLL13TT

KELVINATOR twin tub - KLL13TT



KLL72TT07K

MOTOR FAN PULLEY

KELVINATOR twin tub - KLL72/80TT



LG-4560FW1056B

PULSATOR PULLEY

LG twin tub - WP701P



PH04

PULSATOR PULLEY

DAEWOO twin tub - TT6560; HOOVER twin tub - T3600R; PHILIPS twin tub - 6360T



PN-AB28800

IDLER JOCKEY PULLEY

SPEEDQUEEN top loader - all models
ORIGINAL PART
OEM REF: 268001600



PN-AB28802

IDLER PULLEY SHAFT

SPEEDQUEEN top loader - all models
ORIGINAL PART



PN-AB34232P

MAIN DRIVE PULLEY
SPEEDQUEEN top loader
- AWM351/352, HA4011,
NA3311
ORIGINAL PART



PN-AB38143

MAIN DRIVE PULLEY
SPEEDQUEEN top loader -
LWS11A, LWS21A
ORIGINAL PART



PN-AD54414

IDLER JOCKEY PULLEY
SPEEDQUEEN tumble dryer -
HE4930, NE5313
ORIGINAL PART

PULSATOR HOUSINGS COMPLETE PARTS



PH03

PULSATOR SHAFT AND HOUSING
DAEWOO twin tub - DW7000,
TT6560; HOOVER twin tub -
T3600R; PHILIPS twin tub - 6360T
OEM REF: 4505A17000



PH08

PULSATOR HOUSING NUT
DAEWOO twin tub -
DW7000, TT6560; HOOVER
twin tub - T3600R; PHILIPS
twin tub - 6360T

PULSATORS AND AGITATORS



4819 466 98891

THRUST WASHER KIT
WHIRLPOOL top loaders
- 3LA5800, 3LA5580,
3XLA87W72
ALT: 285587



4819 528 38437

DOG, AGITATOR CLUTCH
WHIRLPOOL top loaders
- 3LA5800, 3LA5580,
3XLA87W72
ALT: 285751



4819 690 18131

DOG AGITATOR (4 PIECES)
WHIRLPOOL top loaders
- 3LA5580XS, 3LSR6233,
3XLA87W72



D3619703500

PULSATOR
DAEWOO 1150 DEFY DTL
115, DTL125, DTL130,
DTL132



HA10116

PULSATOR
twin tubs : AIM - ATT5, BAUER -
TT800, DEFY twinmaid - DTT130,
DTT135, DTT140, DTT141,
DTT142, fridgemaster - WA56P,
HARWOOD - WA56P, SVASA -
WA56P, UNIVA - UT600
ORIGINAL PART



HA20401

PULSATOR
DEFY - DTT146/148



▾ **HS101049**

PULSATOR
HISENSE twin tub - XPB60-2000S/SA, XPB80-2000S/SN



▾ **KL-301113500601**

PULSATOR
KELVINATOR twin tub - KL14TT



▾ **KL-3619705510**

PULSATOR
KELVINATOR top loader - KL15TL



▾ **KL100TT2-47K**

PULSATOR, KELV.
KL100TT2/3/M
KELVINATOR twin tub - KLL100TT2



▾ **KL80TT55K**

PULSATOR ASSEMBLY KELV.
KL80TT
KELVINATOR twin tub - KLL80TT



▾ **KL85TT42K**

PULSATOR ASSEMBLY
KELVINATOR twin tub - KLL85TT



▾ **KL-KF2008S00202**

PULSATOR
KELVINATOR twin tub - KL13TT1/2, KL100TT4/5



▾ **KLL72PULS**

PULSATOR ASSEMBLY
KELVINATOR twin tub - KLL72TT



▾ **KLL72TT54K**

PULSATOR
KELVINATOR twin tub - KLL72TT



▾ **LG-015**

PULSATOR ASSEMBLY
LG top loaders - WF-T1022, WF-T1330, WF-1391, WFT-11C65
ALT: LG-5845FA1829B



▾ **LG-016**

PULSATOR ASSEMBLY
LG top loaders - WFT7016PP, WF-552SPP, WF8071TP, WFT7050TP
OEM REF: 5845EY1003B



▾ **LG-021**

PULSATOR ASSEMBLY
LG top loaders - T8502TDPT, T8510EPT, WFT8018TP, WFT8092, WFT1040TP, WFT1050TP
OEM REF: 5845EY1004D



LG-027

ROLLER ASSEMBLY
P1160, P1360, WP-1100,
WP-1300, WP-9000
ALT: LG-4581EY3002F



LG-029

PULSATOR ASSEMBLY
LG - P1160RWP, P1360RWP,
P1400ROP, WP-1100QS
ALT: 5845EY1006N



LG-5845EY0001C

ROLLER ASSEMBLY
LG Twin Tub
P1160, P1360, WP-1100, WP-
1300, WP-9000



LG-5845FA1829B

PULSATOR ASSEMBLY
LG top loaders - WF-T1022,
WF-T1330, WF-1391, WFT-
11C65



PN-AB33174

AGITATOR
SPEEDQUEEN top loader -
AWM270, AWM351, AWM352,
AWM373, RWM274, RWM373
ORIGINAL PART



PN-AB36507

AGITATOR
SPEEDQUEEN top loader -
LWS11A, LWS21A
ORIGINAL PART



PN-AB36507

AGITATOR
SPEEDQUEEN top loader -
LWS11A, LWS21A
ORIGINAL PART



NT6500-005

PULSATOR
NU-TEC twin tub - NT6500

PUMPS: DRAIN



4819 360 18211

MECHANICAL DRAIN PUMP
WHIRLPOOL top loader - 3LA580XSWO,
3LA5801XXWPO,
3LA5580XSW2
ALT: 3363394



4819 360 18249

MECHANICAL DRAIN PUMP
WHIRLPOOL top loader -
3LSC8255EQO, 3LSR6233EQO,
3XLA87W72BWO,
3XLA87W92BQO
ALT: 3363892



4819 480 58106

PUMP FILTER ASSEMBLY
WHIRLPOOL AFL: FL243,
FL5053, AWM815



A114

DRAIN PUMP
INDESIT dishwasher -
D4000WZ, DG5000, DG5100
OEM REF: 044712



A136

DRAIN PUMP INDESIT AFL - 097, 099, 101, L6 series; INDESIT dishwasher - 111, 114, 115, 116, 2111, 2114, 2115, 2116, D310, D340, D350, D360, LS12, LS18, LS120, P12, P18, D3000 series
OEM REF: LMP204AA1



A136M

DRAIN PUMP - MAGNETIC INDESIT AFL - 097, 099, 101, L6 SERIES; INDESIT dishwasher - 111, 114, 115, 116, 2111, 2114, 2115, 2116, D310, D340, D350, D360, LS12, LS18, LS120, P12, P18, D3000 SERIES



A146

UNIVERSAL DRAIN PUMP Suitable with many makes of AFL'S, dishwashers and twin tubs (complete with three fittings)



A147

DRAIN PUMP Universal synchronous pump - without chamber. Fits LG top loader - WTR1374T



A147-C

DRAIN PUMP - CLIP ON Universal synchronous pump - without chamber. Fits LG top loader - WTR1374T



A215

DRAIN PUMP AND FILTER INDESIT AFL - 2091, 2097, 2099, 2101, W400 series, W600 series, LIMPIA TRE; HITACHI top loader - all models (replacement); KELVINATOR AFL - WAF50NNR, WAF60NNR
OEM REF: LMP205AA1



A290

DRAIN PUMP INDESIT AFL - WG623, WG635; DEFY - DTT146/148
OEM REF: 044998



B111

DRAIN PUMP - UNIVERSAL TWIN TUB PUMP



B111-P

PUMP, UNIV. SYNCHRONOUS+HEAD universal application



BS04

DRAIN PUMP BOSCH AFL - V400 series, VT449 thru VT590; SIEMENS AFL - various models
OEM REF: 1.740.130.618



BS09

DRAIN PUMP - SYNCHRONOUS BOSCH & SIEMENS dishwashers
OEM REF: 165261



BS13

PUMP, BOSCH WFL1200/2060 141896
BOSCH AFL - WFL1200/2060
MOST BOSCH FRONT LOADERS



DY101

DRAIN PUMP - SYNCHRONOUS
DEFY dishwasher - DDW143
OEM REF: 1740300300



DY102

DRAIN PUMP
DEFY AFL - DAW316,
DAW317, DAW318,
DAW320, DAW351
OEM REF: 2880400600



DW005

DRAIN PUMP
DAEWOO - DWF160, DEFY
- DTL115, KELVINATOR -
KL13TL, KL15TL, KL80TL
DEFY DTL 115 / 120 / 125 /
128
OEM REF: 3618957520



DY11

DRAIN PUMP AND FILTER
DEFY AFL - automaid MKI,
MKII; ARISTON AFL - AR410,
AR516, AR616, AR818, LB120,
LB410, LB516, LB615
OEM REF: 008756



DY25M

DRAIN PUMP - MAGNETIC
DEFY AFL - DA505



DY25

DRAIN PUMP
DEFY AFL - DA504, DA505,
DA508, DA656; DEFY
washer/dryer - kombomaid
DW506
OEM REF: 019660



DY63A

DRAIN PUMP - SYNCHRONOUS
DEFY AFL - DA455, 'DAW'
series (MK4)



DY63

DRAIN PUMP
DEFY AFL - DA455, 'DAW'
series (MK4) (synchronous
pump: DY63A)
OEM REF: 023858



DY76

DRAIN PUMP
DEFY dishwasher - dishmaid:
MKI, MKII, MKIII, A, B, C,
3126, 3127, 3128



DY83

REPLACEMENT DRAIN PUMP KIT
DEFY twin tub - ESE550SWP,
twinmaid early; GENERAL
ELECTRIC twin tub - ultra
twin



E117M

PUMP, MAGNETIC
KELVINATOR AFL - A205/6



E117

DRAIN PUMP
KELVINATOR AFL - A205,
A206, A2005, A2006, A5500,
A5501, A5502, A5503,
A5513, A5600, A5601
OEM REF: EZ825180



EC107

DRAIN PUMP

HARWOOD twin tub - W56T; INDESIT/HOOVER dishwasher - D4800, D5000; DAEWOO dishwasher - DD12; KIC AFL - W600K; BAUER AFL - 550; SAMSUNG AFL - SW6004; MERCURY AFL - 518U; UNIVA AFL - 518U; DAEWOO AFL - DX550, DX600T; HOOVER AFL - HW600

OEM REF: 4819 360 18217



G126

DRAIN PUMP

AEG dishwasher - FAVORIT series (most models)

OEM REF: 6460855530



HS103030

DRAIN PUMP

HISENSE - XQP85-70



KM062

DRAIN PUMP AND FILTER

PHILIPS AFL - AWB938, AWB939; WHIRLPOOL AFL - AWG372, AWG376, AWL352, AWM807, AWM815, AWM875

OEM REF: 4819 360 18189 NATIONAL, HITACHI, TOSHIBA ETC.



LG-009

DRAIN PUMP

LG top loaders - WPB7550, WP9916PT, WP720, WP1100QS, WA29.D05

OEM REF: 2W06291B



LG-5859EY1002A

PUMP, DRAIN

WP8100, 8200, 9100/14 LG - WP620NP, WP-720NP



G111

DRAIN PUMP AND FILTER

AEG AFL - 505, 509, 520, 528, 540, 570, 620, 621, 633, 810, 9015

OEM REF: 645425005



G115

DRAIN PUMP AND FILTER

AEG AFL - 251, 505N, 508, 509N, 525, 530, 535, 536, 538, 541, 650, 680, 700, 715, 720, 833, 850, 950, 1000

OEM REF: 645430540



HA-300

DRAIN PUMP

Dishwashers: BAUER / WESTPOINT- WQP12, INDESIT - DG6100, KELVINATOR - KD12DW/SS2, KD14



KLL72TT18K

DRAIN PUMP

KELVINATOR twin tub - KLL72TT



L18

DRAIN PUMP AND FILTER

PHILIPS AFL - AWB938, AWB939; WHIRLPOOL AFL - AWG372, AWG376, AWL352, AWM807, AWM815, AWM875

OEM REF: 4819 360 18189



LG-011

DRAIN PUMP ASSEMBLY

LG Top Loader WFT8016, WFT8018, WFT7015



PN-AB31968

MECHANICAL DRAIN PUMP - 2 PORT

SPEEDQUEEN top loader - HA4011, HA4511, NA3311 ORIGINAL PART



PN-AB31969

MECHANICAL DRAIN PUMP - 4 PORT
SPEEDQUEEN top loader - AWM351, AWM352, EA1211, WA4981
ORIGINAL PART



PN-AB36863P

MECHANICAL DRAIN PUMP
SPEEDQUEEN top loader - AWM270
ORIGINAL PART



PN-AB648P3

DRAIN PUMP
SPEEDQUEEN top loader - AWM372, AWM373, RWM373
ORIGINAL PART



TSS07

DRAIN PUMP
SAMSUNG - WA1385/75B7/10R3



TSS08

DRAIN PUMP
SAMSUNG - SWT65AI, WA75B7/75B9, WT10S1/ S2/80, SW70A1/X1P/X2P
OEM REF: DC31-00056A



TSS11

DRAIN PUMP
KELVINATOR AFL - KL750CM
SAMSUNG T/LOADERS 2 AIR VENT BLOCKED



WPK01

DRAIN PUMP
KELVINATOR dishwasher : KD12, WESTPOINT: WQP8, WQP12

SEALS: OIL, CIRCULAR

PART NUMBER	SIZE	SUITABLE FOR
A129	12 x 22 x 7mm	BAUER/UNIVA/HOOVER/KIC AFL HUB SEAL
A204	35 x 52 x 12mm	INDESIT AFL HUB SEAL
B121	6 x 22 x 7mm	UNIVERSAL DRAIN PUMP SEAL
CW122	25 x 47 x 7mm	CANDY HUB SEAL
D28734	30 x 55/80 x 10/13	DEFY AFL - NEW TYPE
DY28A	30 x 55 x 7mm	DEFY AFL HUB SEAL (2 x REQUIRED)
DY72		DEFY AFL OUTER HUB SEAL
DY77	6 x 20 x 6mm	DEFY TWIN TUB - ESE550 PUMP SEAL



PART NUMBER	SIZE	SUITABLE FOR
DY86A	24 x 55 x 10/12mm	DEFY AUTOMAID DAW285, DAW310
EC119A	21 x 40 x 7mm	BAUER/UNIVA/HOOVER/KIC AFL HUB SEAL
E128	23 x 47 x 10mm	KELVINATOR AFL HUB SEAL
EC146	35 x 62 x 10mm	WHIRLPOOL AFL HUB SEAL - AWG336, AWG372, AWL352
G122	40 x 70/80 x 12/14mm	AEG AFL 500 SERIES HUB SEAL
G142	32 x 56 x 10mm	AEG AFL BELLA 64SL & 85SL HUB SEAL
HIT1	5 x 18 x 7mm	HITACHI TWIN TUB DRAIN PUMP SEAL
KM047		HOOVER AFL 800RPM HUB SEAL
LG-008	9.5 x 66 x 37mm	LG AFL - LVD8350, WD8030
L19	22 x 40 x 10mm	UNIVERSAL
NAT1	4,4 x 17,2 x 8mm	NATIONAL TWIN TUB DRAIN PUMP SEAL
PN-AB28114		SPEEDQUEEN TOP LOADER GEARBOX SEAL
SPS1	4,5 x 16/57 x 7/8,5mm	SOLAY PUMP SEAL
SPS2	4,5 x 16/57 x 7/8,5mm	SOLAY PUMP FLANGED SEAL
WS1	6 x 21,5/55 x 12mm	PLASET PUMP FLANGED SEAL
WS2	5 x 22/53 x 11mm	COPRECI PUMP FLANGED SEAL
WS3	6 x 22/67 x 8/10mm	UNIVERSAL PUMP FLANGED SEAL
ZZZDY02SEAL	25 x 50 x 10mm	DEFY AFL -DAW350
ZZZH25SEAL	14 x 30 x 7mm	UNIVERSAL
ZZZPH03	10 x 26 x 7mm	UNIVERSAL

SEALS: FELT, GEARBOX, CARBON FACE



481953278121

**SEAL THRUST
PLUGWHIRLPOOL top
loaders - 3LA5800,
3LA5580, 3XLA87W72**



4820 000 07528

**SEAL KIT
WHIRLPOOL tumble dryer -
GLE5700
ORIGINAL PART**



A197

**CIRCULATING PUMP SEAL KIT
DEFY dishwasher - dishmaid:
MKI, MKII, A, B, C, 3126, 3127,
3128; INDESIT dishwasher
- 111, 114, 115, 116, 2111,
2114, 2115, 2116, D310, D340,
D350, D360, LS12, LS18, LS120,
P12, P18
OEM REF: GKH005AA1**



DY72

**DRUM SEAL
DEFY automaid maid-large**



PN-AD56088

**FELT SEAL
SPEEDQUEEN tumble dryer -
HE4930, NE5313
ORIGINAL PART**



W10612022

**DRUM FELT SEAL
WHIRLPOOL dryers
- 3XLER5435HQ,
3LER5436EQ1,
3LHER5437JQ3**

SOLENOID VALVES: HIGH PRESSURE



4819 033 60397

**WATER SOLENOID VALVE
WHIRLPOOL top loaders - all
U.S.A. Models; also suitable
for use on HOOVER &
SPEEDQUEEN top loaders
ALT: 3360393**



A176

**SOLENOID REDUCER
universal application**



DV1

**UNIVERSAL DOUBLE WATER
SOLENOID VALVE - IN LINE
DEFY dishwasher - some
early models; INDESIT AFL -
101,2101, 450, L10**



DV2

**UNIVERSAL DOUBLE WATER
SOLENOID VALVE - 90 deg
removeable bracket -
universal application**



DV3

**UNIVERSAL DOUBLE WATER
SOLENOID
Suitable for most USA top
loaders**



G101

**SINGLE WATER SOLENOID
VALVE
AEG AFL - 800E, 803, 804,
BELLA SL
OEM REF: 645023765**



G153

TRIPLE ELECTROVALVE
AEG AFL'S 500 series
OEM REF: 645238280



KL-3615403851

VALVE, INLET-HOT
KELVINATOR top loader -
KL10TL



KL-3615407920

VALVE, INLET TRIPLE
KELVINATOR top loader -
KL15TL



LG-024

INLET VALVE
LG top loader - WST1330TP
KL-3615407920
OEM REF: 5220FA1620G



PN-AB35856

WATER SOLENOID VALVE
HOOVER top loader - LATH100,
SWHA2501, SHWA2506, SHWA2507,
LATH100; SPEEDQUEEN top loader - all
models
ORIGINAL PART



S-DC62-00024A

VALVE ASSEMBLY - 3 WAY
SAMSUNG top loader
- B1415, WA1385 -
KELVINATOR TOP LOADERS
DEFY TOP LOADERS DTL125
ORIGINAL PART



SV1

**UNIVERSAL SINGLE WATER
SOLENOID VALVE**
90 deg - removable bracket



SV2

**SINGLE WATER SOLENOID VALVE - IN
LINE**
DEFY AFL - AH, DA504, DA505,
DA508, DA656, all kombos; INDESIT
AFL - 2099, W400/W600 series,
WN461WO, WN657, WN663



SV3

**SINGLE WATER SOLENOID
VALVE - 90 deg (24 VOLT)**
Universal application



TV2

**UNIVERSAL TRIPLE WATER
SOLENOID VALVE - IN LINE**
DEFY dishwasher - some models;
INDESIT AFL - 099, 2097, L6 series;
INDESIT dishwasher - 115, 116,
2115, 2116, D350, LS12, LS120,
LS18, P12, P18



TV3

**UNIVERSAL TRIPLE WARE
SOLENOID VALVE - 90 DEG.**
Universal application

SPIN TUBS: COMPLETE, PARTS



D64230

SPIN MAT - 280mm diameter
DEFY twin tub - DTT146



HA-007

SPIN COUPLING
BAUER - TTW9; KELVINATOR
twin tubs



HA10157

SPIN MAT - 26CM
DEFY/BAUER twin tub -
DTT130



HA10501

SPIN BASKET
twin tubs : AIM - ATT5; BAUER
- TT800; DEFY twinmaid -
DTT130, DTT135, DTT140,
DTT141, DTT142, fridgemaster
- WA56P; HARWOOD - WA56P;
SVASA - WA56P; UNIVA - UT600



HA20704

SPIN COUPLING
DEFY - DTT146/148



KL100TT2-25K

BRAKE PLATE ONLY
KELVINATOR twin tub -
KLL100TT2



KL100TT56K

COUPLER, MOTOR
KELVINATOR twin tub -
KLL100TT/4/5



KL80TT123K

SPIN COVER, TRANSPARENT
KELVINATOR twin tub -
KLL80TT



KL85TT97K

MOTOR COUPLER
KELVINATOR twin tub -
KLL85TT



KL-PI288S-0412

SPIN COUPLING
KELVINATOR twin tub -
KL100TT2, KL100TT3,
KL100TTM, KL13TT



SM3 / SM5

**SPIN MAT 280mm / 265mm
DIAMETER**
universal application



SUSPENSIONS: SHOCKS, DAMPERS, PADS



4801 101 00402

SUSPENSION SPRING
WHIRLPOOL top loaders
- all USA models except
3LA5800XP
ALT: 388492



4819 033 63660

BASE PAD
WHIRLPOOL top loaders - all
USA models
ALT: 285744



D2816870600

SHOCK ASSEMBLY
DEFY AFL - DA656, DAW
285, DAW350, DAW356
ALT: D28402



DY31

DAMPER LEAF SPRING
DEFY AFL - automaid MKI,
AA thru AH, DA455, 'DAW'
series, (MK4)
OEM REF: 025811



EC116

DAMPER FRICTION PAD
BAUER AFL - 550; DAEWOO
AFL - DX550/600; HOOVER
- HW600; KIC - W600K;
MERCURY - 518U; SAMSUNG
- SW6004; UNIVA - 550



G135

SHOCK ABSORBER
KELVINATOR AFL - A5513,
WAF50NNR, WAF60NNR;
also fits AEG, BOSCH,
SIEMENS and OCEAN AFL'S



KL-0020700365

SHOCK ABSORBER
KELVINATOR AFL - KL60DFL
ORIGINAL PART



KL-00330014038

DAMPER PAD
KELVINATOR twin tubs -
KL90TT/KL72TT



KL-3615116100

SPRING, SUSPENSION
KELVINATOR - KL600FL



KL-3619804200

SUSPENSION, BLACK
KELVINATOR top loader -
KL80TL



KL-3619804300

SUSPENSION BLUE
KELVINATOR top loader -
KL80TL



KL-3619805500

SUSPENSION
KELVINATOR top loader -
KL15TL



KL100TT2-20K

MOUNT ASSEMBLY, SPIN MOTOR - KL100TT2
KELVINATOR twin tub - KLL100TT2



KL-KL750CM-06

SHOCK ABSORBER
KELVINATOR AFL - KL750CM



LG-022

DAMPER ASSEMBLY FRICTION (BLACK)
LG AFL - WD8013F
OEM REF: 4900FR2030H



LG-383EER3001G

SHOCK ABSORBER ASSEMBLY
WD-10160F, WD-10165,
WD-14366, WD-80134



LG-4901EY4001A

DAMPER ASSEMBLY
twin tub - P1360, WP-1100,
WP-1300



LG-4902EA2001B

SUSPENSION ASSEMBLY
LG AFL - WFG7050TP



LG-4902FA1953F

SUSPENSION ASSEMBLY
AFL-T1003, T1008, WF-T1040,
WF-T1050, WF-T8018



LG-4902FA1953G

SUSPENSION ASSEMBLY
AFL: T1003, T1008, WF-T1040,
WF-T1050, WF-T8018



PN-AB27239

SPRING, LEG NA3311
SPEEDQUEEN - NA3311



SWITCHES: DOOR, TEMPERATURE, MAINS



4812 276 18309

SWITCH START/RESET
WHIRLPOOL dryer -
AWZ121/220



4812 276 18484

LID SWITCH
WHIRLPOOL top loader -
3LSLR6233
ALT: 8318084



4819 039 50298

SWITCH, LID
WHIRLPOOL top loaders -
3LSR6233, 3LSLR6233
ALT: 3950298



4819 276 18329

SWITCH, PUSH TO START
WHIRLPOOL dryer - 3LER5434



4819 277 18172

LID SWITCH
WHIRLPOOL top loader -
3LA5580XSWS2
ALT: 279347



4819 277 18187

LID SWITCH
WHIRLPOOL top loader
- 3LA5800XPWO,
3LA5800XSWPO,
3LSC8255EQO,
3LSR6233EQO,
3XLA87W72BWO,
3XLA87W92BQO
ALT: 285671



A155

SWITCH
INDESIT D/W DG5100,
DG6100, WESTPOINT
WQP12, KELVINATOR - KD12



A282

MAINS SWITCH - DOUBLE POLE
INDESIT AFL - WN461WO,
WN657WF, WN663WO; INDESIT
dishwasher - D3000WZ,
D4000WZ
OEM REF: 034349/041184/034376



DY47

TWO HEAT ROTARY SWITCH
DEFY tumble dryer - autodry
36, autodry 45
OEM REF: 9720172



DY48

BELT BRAKE SWITCH
DEFY tumble dryer - autodrier
3.6, autodry 36, autodry 45,
sensimatic 45, varidry
OEM REF: 9720037



DY104

ON/OFF SWITCH
DEFY - DAW265/ TD265



E116

TWO HEAT ROCKER SWITCH
KELVINATOR tumble dryer
- N130, N140; GENERAL
ELECTRIC tumble dryer - DE7
OEM REF: AD860283



EC124

MAINS SWITCH - 6 CONTACT
INDESIT/HOOVER
dishwasher - D4800, D5000;
DAEWOO dishwasher -
DD12
ORIGINAL PART



KL-00216001231508

SWITCH - POWER
KELVINATOR AFL - KL60DFL



KL-178620031

LID SWITCH
KELVINATOR top loaders -
most models
ORIGINAL PART



PBS2

**UNIVERSAL TWO WAY PUSH
BUTTON SWITCH**
DEFY tumble dryer -
autodry 5: D150, 'DTD'
series; INDESIT dishwasher
- 115, 116, 2115, 2116;
INDESIT AFL - W400, W410,
W411, W420, W421,
W500F; KELVINATOR AFL -
A5500/1/2/3/13, A5600/1,
WAF50NNR, WAF60NNR
**INDESIT OEM REF:
MEA015FA1**



LG-4988EY2004A

LEVER, SELECTOR
P1160, P1360, P1400,
P1860, WP-1100, WP-1300,
WP620, WP720, WP8200,
WP9000



PBS6

**PUSH BUTTON SWITCH - 7
CONTACT**
Universal application



PN-AB27612

LID SWITCH
SPEEDQUEEN top loader - all
models
ORIGINAL PART



PN-AD504570

DOOR SWITCH
SPEEDQUEEN - AEM453/77/
EE2007



PN-AD55882

START SWITCH
SPEEDQUEEN tumble dryer -
HE4930, NE5313
ORIGINAL PART



SW1

UNIVERSAL 3 TAG MICRO SWITCH
normally closed + normally open



SW19

MICROSWITCH 3 CONTACT - SHORT ARM
Normally open, normally closed



SW20

UNIVERSAL 2 TAG MICRO SWITCH
normally closed



SW21

UNIVERSAL 2 TAG MICRO SWITCH
normally closed



SW30

UNIVERSAL 3 TAG MICRO SWITCH
normally closed + normally open - long arm

THERMALS: OVERLOADS, TOC'S



DY79

THERMAL FUSE
DEFY tumble dryer - autodry 5: D150, 'DTD' series;
KELVINATOR tumble dryer - N130, N140, T50WF
OEM REF: 023372



LG-6931EL3001D

THERMOSTAT, RESET - 170 deg NC
Tumble dryer: RC8001C, RC-9011B, RC-9011C, TD-C70040, TD-C75120, TD-C70045

THERMOSTATS



041086

SAFETY THERMOSTAT
INDESIT dishwasher - D4000WZ, D5000WG, D5100WZ
ORIGINAL PART



4812 259 28681

THERMOSTAT KIT
WHIRLPOOL tumble dryers - AWZ650, AWZ410, AWZ750



4819 282 28673

THERMAL CUT-OFF
WHIRLPOOL dryers - GLE5700, 3LHER5434
alt: 279816



D22983

VARIABLE THERMOSTAT 0-90degC BUTTON PROBE
DEFY AFL - DA508, 'DAW' series (de luxe models only);
HOOVER AFL - HW600; KIC AFL - W600K; WHIRLPOOL AFL - KW600
ORIGINAL PART



D61206
THERMOSTAT
 DEFY dishmaid - DDW118



PN-AD56082
FIXED THERMOSTAT - 1 STEP
HI-TEMP
 SPEEDQUEEN tumble dryer -
 HE4930, NE5313
ORIGINAL PART

THERMOSTATS: AUTO

PART NUMBER	KIND	SUITABLE FOR
TS034NA	BI-METALLIC	34°C NORMALLY OPEN
TS035/93NC	BI-METALLIC	35°C NORMALLY CLOSED + 93°C NORMALLY CLOSED
TST050	BI-METALLIC, BUTTON	50°C NORMALLY CLOSED
TS057NC	BI-METALLIC	57°C NORMALLY CLOSED
TST060	BI-METALLIC, BUTTON	60°C NORMALLY CLOSED
TST080	BI-METALLIC, BUTTON	80°C NORMALLY CLOSED
TST090	BI-METALLIC, BUTTON	90°C NORMALLY CLOSED
TST095MR	BI-METALLIC, BUTTON	95°C NORMALLY CLOSED (MANUAL RESET)
TST100	BI-METALLIC, BUTTON	100°C NORMALLY CLOSED
TST120	BI-METALLIC, BUTTON	120°C NORMALLY CLOSED
TST130	BI-METALLIC, BUTTON	130°C NORMALLY CLOSED
TST140	BI-METALLIC, BUTTON	140°C NORMALLY CLOSED
TST150	BI-METALLIC, BUTTON	150°C NORMALLY CLOSED
TST150MR	BI-METALLIC, BUTTON	150°C NORMALL CLOSED (MANUAL RESET)
TST180	BI-METALLIC, BUTTON	180°C NORMALLY CLOSED



TIMERS



450RC50000

SPIN TIMER S-42PM
KIC twin tub - TT524P (4 lead)



4812 218 38351

CONTROL BOARD (UCB)
WHIRLPOOL dishwasher -
ADP4305



4801 101 00262

TIMER ASSEMBLY
WHIRLPOOL - 3SWTW5205SQO



4812 905 08125

TIMER
WHIRLPOOL dishwasher -
ADP533, ADP553



4819 039 50560

TIMER
WHIRLPOOL top
loader - 3LSC8255EQO,
3LSR6233EQO



4819 282 18701

TIMER
WHIRLPOOL tumble dryer -
3LER5434BW1, 3LER5436EQO,
3XLER5435HQO



BAD860859

TIMER
KELVINATOR tumble dryer -
J2500, J2501, J2502, J2503
OEM REF: 061477



D1883630100

TIMER ASSEMBLY
DEFY dishwasher -
DDW126



D27574

COTROL MODULE
DEFY kombomaid



D2818280100

TIMER ASSEMBLY
DEFY AFL - 'DAW' models
DAW 350 / 355 / 356
EC 4889.01



D28578

TIMER
DEFY automaid deluxe
DAW285



D29528

TIMER EC4687.02
DEFY dishwasher -
DDW115/117



D68310

TIMER 1760/2/5.00
DEFY tumble dryer - autodry
5: D150, 'DTD' series
ORIGINAL PART



HA-001

WASH TIMER
HAIER - XPB90; BAUER -
TTW4, TTW9



HA10606

WASH TIMER
WASHTIMER DEFY TWIN TUB
DTT130-5



HA10607

WASH TIMER
DEFY twin tub - DTT141



HA22001

WASH TIMER
DEFY - DTT146/148



HKLW15

WASH TIMER
HOOVER twin tub - KLW504
(5 LEAD)



HS102014

WASH TIMER ASSEMBLY.
HISENSE twin tub - XPB60-
2000S/SA



KL-0024000888

TIMER EC4885.01A
KELVINATOR AFL - KL60FLM



KL-03030618S00

WASH TIMER ASSEMBLY
KELVINATOR TWIN TUB -
KL100TT4, KL13TT2



KL-03040618S00

SPIN TIMER
KELVINATOR TWIN TUBS -
KL100TT4, KL13TT2



KL-302411900644

SPIN TIMER
KELVINATOR TWIN TUB -
KL14TT/2



KL-KF568S00108

SELECTOR SWITCH
KELVINATOR twin tub -
KL13TT1, KL100TT5



KL-KF568S00110

SPIN TIMER
KELVINATOR TWIN TUB -
KL13TT1, KL100TT5



KL-KTD600W-02

PCB ASSEMBLY
KELVINATOR TUMBLE DRYER
- KTD600W/WD



KL-PRPSSW2Y01

P.C. BOARD - KL13TL
KELVINATOR top loader -
KL13TL



KL80TT109K

WASH TIMER
KELVINATOR twin tub - KLL72TT,
KLL80TT,
KL100TT2/3



KL80TT112K

P.C. BOARD - KL10TL
KELVINATOR top loader -
KL10TL



KL85TT11K

WASH TIMER
KELVINATOR twin tub -
KLL85TT



LG-001

WASH TIMER
LG twin tub - WP703/10/720
OEM REF: 6915FW2100A



LG-6871EC1089A

**PWB ASSEMBLY MAIN WF-
T7030TP**
AFL: WF-T9230TP, WF-
T9235TP



LG-6871EC1113F

PCB ASSEMBLY
LG TOP LOADER -
TDC70045E



LG-6871EL1003A

PCB ASSEMBLY
dryer: TD-V75120E, TD-
V75125E



LG-6871EN1043B

**PCB ASSEMBLY, MAIN-
WD10165FU**
AFL: WD-10160FU, WD-
10165FU



LG-6915EY1003L

MODULE, TIMER
twin tubs : P1400ROP, WP-
9000QS



LG-6915EY1010B

TIMER, CYCLE
LG twin tub -WP8050



NT004

SPIN TIMER
NU-TEC twin tub - NTT5500,
NTT6500



PH06

SPIN TIMER - S313A
DAEWOO twin tub -
DW1070P, DW3633P,
DW7000, T3600R, TT6560
(4 LEAD)
OEM REF: 4505D50000



PH07

WASH TIMER
DAEWOO twin tub - DW1070P,
DW3633P, DW7000, T3600R,
TT6560 (6 lead)
OEM REF: 4505D47000



PN-AB200604

TIMER ASSEMBLY
00007000816
SPEEDQUEEN - LWS11N



PN-AB28719

TIMER
SPEEDQUEEN top loader -
EA1010, EA1011, EA1020,
EA1021



PN-AB28948

TIMER
SPEEDQUEEN top loader -
HA4011



PN-AB31241

TIMER
SPEEDQUEEN top loader -
AWM351, AWM352, NA3311



PN-AB35531

TIMER
AWM351 (dual harness)



PN-AB36288

TIMER
SPEEDQUEEN top loader -
AWM270



PN-AB37995

TIMER
SPEEDQUEEN top loader -
LWS11A, RWM274



PN-AB39445

TIMER
AWM372, AWM373, LWS21A,
RWM373



TEC03

SPIN TIMER
TELEFUNKEN twin tub -
TTT65



TSS01

WASH TIMER - SM-K15BE(B)
SAMSUNG / KIC twin tub -
PAL400, SW401 (4 LEAD)
OEM REF:54302-202-010



TSS04

WASH TIMER
SAMSUNG TWIN TUB -
SWT65AIP
ALT: S-DC45-10009A



TSS16

WASH TIMER DXT-35SF-104
SAMSUNG TWIN TUB:
WT10S2P, WT13S2P,
WT13J7P

VENTING: KITS, PARTS



PN-LS70104

VENTING HOSE
SPEEDQUEEN tumble dryers
- all models
ORIGINAL PART



02

FLOORCARE



BAGS: CLOTH



FLT33

CLOTH FILTER
ELECTROLUX vacuum cleaners - fits all models with cartridge filter



FLT34

CLOTH FILTER
HOOVER vacuum cleaner - AQUAPLUS 1700 Series, AQUAPLUS 2200 Series, AQUAMASTER Series



FLT40

CLOTH FILTER
ELECTROLUX vacuum cleaners - fits all models without cartridge filter



FLT41

CLOTH FILTER
ELECTROLUX vacuum cleaners - upright model ARIEL Z2270



FLT42

CLOTH FILTER
ELECTROLUX vacuum cleaners - cylinder models HYPERION EV4602



FLT44

CLOTH FILTER
ELECTROLUX VACUUM CLEANERS - PHOBOS



FLT57

CLOTH BAG
ELECTROLUX 4202/3 MIGHTY MITE



HCF 17

CLOTH FILTER
CONTI vacuum cleaner - TWISTER, TWISTER JUMBO



HCF 20

FILTER BAG
Fits various makes of vacuum cleaners



HCF 264

CLOTH FILTER BAG
LG vacuum - V-CQ243 / 253NT/ND/ST/SD/STU/STV/STQ/HT/HTV/HTU/HTQ, V-CQ263/NT/ND/ST/SD/STU/STV/STQ/STQB/HT/HTV



HCF 584

CLOTH FILTER BAG
LG vacuum cleaner - V-CB564ST/VTCB574SD; V-CB574ST/HTQ/HTU/HEU/HEQ; V-CB584ST/STQ/SEQ/HT/HTQ/HTU/HEQ/HEU

BAGS: DISPOSABLE PAPER

AEG



HC 252

SYNTHETIC BAGS - PACK OF 4
AEG GROUP 24S models -
VAMPYR 700-799, 800-899,
6002, 6100-7999; VAMPYR TC
SERIES, VAMPYR PRO EDITION
BAG



HC 352

SYNTHETIC BAGS - PACK OF 4
AEG GROUP 28S models
- VAMPYR 5000-5999,
CE220/235/250/270, ERGO
ESSENCE AE 4550-4594, VAMPYR
ACE, CE, VCE, VEUROPE, YCE - BAG



HC 552

SYNTHETIC BAGS - PACK OF 8
AEG GROUP 5S models -
VAMPYRINO AE 3450, 3455,
3460, 3465; SMART 140, 150,
160, 170
BAG



U030

PAPER BAG - PACK OF 5
AEG VACUUM CLEANER -
VAMPYR : 502, 508, 509,
602, 610, 6002, 6006, 6009



U077

PAPER BAG - PACK OF 5
AEG VACUUM CLEANER -
COMPACT : 400, 402, 406,
407, 415 (GROUP 11,13)



U124

PAPER BAG - PACK OF 5
AEG VACUUM CLEANER -
VAMPYR: 731i, 751i, 763i,
791i, 831i, 841i, 881i, 6200,
7000, 8000 SERIES (GROUP
22, 23, 24, 25)



U154

PAPER BAG - PACK OF 5
AEG VACUUM CLEANER -
VAMPYR : 5000 SERIES
(GROUP 28)



U461

PAPER BAG - PACK OF 5
AEG VACUUM CLEANER -
VAMPYR EXCLUSIV 1300



U551

PAPER BAG - PACK OF 5
AEG VACUUM CLEANER -
VAMPYR

AQUAVAC

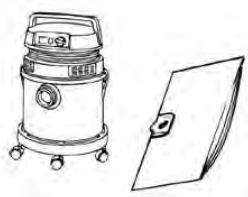

U043

PAPER BAG - PACK OF 5
AQUAVAC VACUUM CLEANER
- 600 SERIES, 700 SERIES



U044

PAPER BAG - PACK OF 5
AQUAVAC VACUUM CLEANER
- 760, 960, 8504, SUPER 40



BOSCH



HC 253

PAPER BAG - PACK OF 5
BOSCH VZ52 AFP TYPE P,
SIEMENS VS08



U034

PAPER BAG - PACK OF 5
BOSCH VACUUM CLEANER -
BS1, BS11, BS12

U078



PAPER BAG - PACK OF 5
BOSCH VACUUM CLEANER
- BBZ22AF, BBS22, ALPHA:
210, 221, 502, 2200,
BS52, BS58, OPTIMA: 203,
BBS5000

CAPIL



U026

PAPER BAG - PACK OF 5
CAPIL VACUUM CLEANER -
CEV1001

DELONGHI



HC 843

PAPER BAG - PACK OF 5
BOSCH VZ52 AFP TYPE P,
SIEMENS VS08



U058

PAPER BAG - PACK OF 5
DELONGHI VACUUM
CLEANER - V81
ALT: HC 843

U118



PAPER BAG - PACK OF 5
DELONGHI VACUUM
CLEANER - WET & DRY
MODELS

ELECTROLUX

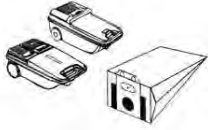

HC 081

PAPER BAG - PACK OF 5
ELECTROLUX VACUUM
CLEANER - Z348, Z350, Z350E,
CYCLONE : Z370, 2000 SERIES
(All cylinder models)

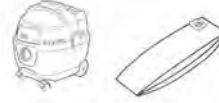

HC 083

PAPER BAG - PACK OF 3
ELECTROLUX - FLEXIO
BUSINESS
NEW



U009

PAPER BAG - PACK OF 5
ELECTROLUX VACUUM
CLEANER - Z330, Z345

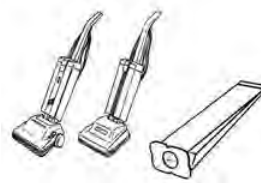

U015

PAPER BAG - PACK OF 5
ELECTROLUX VACUUM
CLEANER - Z500, Z502,
Z504, Z506, Z506E, Z522,
Z550, Z560



U015

PAPER BAG - PACK OF 5
ELECTROLUX VACUUM CLEANER
- Z348, Z350, Z350E, CYCLONE :
Z370, 2000 SERIES (All cylinder
models)



U032

PAPER BAG - PACK OF 10
ELECTROLUX VACUUM CLEANER -
Z164



U036

PAPER BAG - PACK OF 5
ELECTROLUX VACUUM CLEANER
- SLIMLINE : Z154, Z160, Z165,
Z174, Z180, Z185E, Z230, Z260,
Z280, Z290



U048

PAPER BAG - PACK OF 5
ELECTROLUX VACUUM
CLEANER - COMMERCIAL
CANISTER : Z925



U085

PAPER BAG - PACK OF 5
ELECTROLUX VACUUM CLEANER
- 610, 612E, TURBO: Z410,
Z411, Z414, Z420, Z424, Z434,
GLIDER: 495, 496



U110

PAPER BAG - PACK OF 5
ELECTROLUX VACUUM
CLEANER - TORNADO : 701



U115

PAPER BAG - PACK OF 5
ELECTROLUX VACUUM
CLEANER - TWINSTREAM:
Z76, Z77, Z785 WET & DRY



U118

PAPER BAG - PACK OF 5
ELECTROLUX VACUUM
CLEANER - HURRICANE:
2000, 3000 WET & DRY,
STORMCHASER



U132

PAPER BAG - PACK OF 5
ELECTROLUX VACUUM CLEANER
- HARMONY: Z2520, Z2530



U142

PAPER BAG - PACK OF 5
ELECTROLUX VACUUM
CLEANER - Z1440, Z1480
WIDE TRACK



U461

**PAPER BAG - PACK OF 5
ELECTROLUX VACUUM
CLEANER - NISHA**



U550

**ELECTROLUX VACUUM
CLEANER - MIGHTY MITEZ
4202, 4203
HC 550**

GOBLIN



U026

**PAPER BAG - PACK OF 5
GOBLIN VACUUM CLEANER -
400 SERIES, 800, 1000**



U044

**PAPER BAG - PACK OF 5
GOBLIN VACUUM CLEANER -
1000 WET & DRY**



U174

**PAPER BAG - PACK OF 5
GOBLIN VACUUM CLEANER
- AZTEC 1200, 1300, 1300E,
1400HF**



LUX-E200

**PAPER BAG
LUX EXCELLIO DUST BAGS**

HOLLAND



U046

**PAPER BAG - PACK OF 5
HOLLAND ELECTRO VACUUM
CLEANER - 4100, 4200, 4300,
4400**

HOOVER



HC 015

**PAPER BAG - PACK OF 10
HOOVER CV015 VAC-U-MATE,
CV119 VAC-U-CLEAN**



HC 019

**PAPER BAG - PACK OF 5
HOOVER CV019 EUROVAC**

U002



**PAPER BAG - PACK OF 5
HOOVER VACUUM CLEANER
- JUNIOR: 1334, 1346, 1358,
U1012, U1014, U1018,
U1202, U1204, U1254,
SENIOR: 652, 652A, 652C,
U4006, U4016, U4082,
U4208, U4288, U7010**



U004

**PAPER BAG - PACK OF 5
HOOVER VACUUM CLEANER
- CONCEPT 1: U3101,
U4203, U4324, U4342,
NEW SERIES: C1413, U5065
SANYO VACUUM CLEANER :
SC-U7050**



U017

PAPER BAG - PACK OF 5
HOOVER VACUUM CLEANER -
SENSOTRONIC: S3128, S3134,
S3150, S4350



U040

PAPER BAG - PACK OF 5
HOOVER VACUUM CLEANER
- COMPACT : S3194, S3198,
S3396, S3398, SPIRIT:
S3498, S3706



U041

PAPER BAG - PACK OF 5
HOOVER VACUUM
CLEANER - TURBOPOWER
1: U1100, U1220, U1222,
U2198, U2332, U2336,
U2558, U2604, U2684/D,
U2716, U2795, U2796,
TURBOMASTER U5094

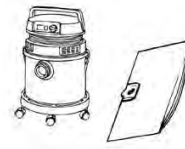

U043

PAPER BAG - PACK OF 5
HOOVER VACUUM CLEANER
- S4000 SERIES WET & DRY
EARLY



U099

PAPER BAG - PACK OF 5
HOOVER VACUUM
CLEANER - AQUAMASTER:
S4396, S4398, S4470,
S4472, S4484, AQUAJET
ELECTRONIC: S4488



U120

PAPER BAG - PACK OF 5
HOOVER VACUUM CLEANER
- TURBOPOWER 2: U2462,
U2464, TURBOPOWER 3:
U2806, U2812, U2878



U134

PAPER BAG - PACK OF 5
HOOVER VACUUM CLEANER -
ZW9036



U722

PAPER BAG - PACK OF 5
HOOVER VACUUM CLEANER
- TRIUMPH UV110

KARCHER

HC 830

PAPER BAGS - PACK OF 5
KARCHER A2204, A2234PT,
A2254ME, A2504, A2534PT,
A2554ME, A2604, A2654ME,
2201F, A2201, A2231PT,
A2251ME, 2901F, A 2901,
3000 PLUS, A3100, K2150
BAG



U047

PAPER BAG - PACK OF 5
KARCHER VACUUM CLEANER
- TBS32



U808

PAPER BAG - PACK OF 3
KARCHER VACUUM CLEANER
- 2500



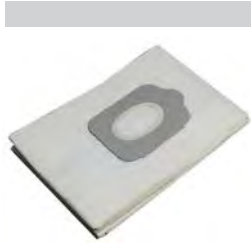

KIRBY

U091

PAPER BAG - PACK OF 5
KIRBY VACUUM CLEANER -
HERATIGE CLEANING SYSTEM,
LEGEND, LEGEND 2



U092

PAPER BAG - PACK OF 5
KIRBY VACUUM CLEANER
- HERATIGE 2 CLEANING
SYSTEM



U195

PAPER BAG - PACK OF 5
KIRBY VACUUM CLEANER -
GENERATION 3/4/5 CLEANING
SYSTEM



LG

HC 243

PAPER BAG - PACK OF 5
LG VACUUM CLEANER -
V-CP243NDN / NTN V-CP243RDN
/ RTN /RD V-CP243NB / NBN / ND
V-CP247NB / NBN /ND



MERCURY

U034

PAPER BAG - PACK OF 5
MERCURY VACUUM CLEANER -
VC800W



U078

PAPER BAG - PACK OF 5
MERCURY VACUUM CLEANER
- VC1000



U134

PAPER BAG - PACK OF 5
MERCURY VACUUM CLEANER
- VC1100H



MIELE

HC 921

SYNTHETIC BAGS - PACK OF 4
MIELE TYPE F/J/M MODELS
- S240 SERIES, S250 SERIES,
S290 SERIES, S300 SERIES,
S500 SERIES, S700 SERIES,
S4000 SERIES, MODELS WITH 3
WHEELS - **BAG**



HC 941

SYNTHETIC BAGS - PACK OF 4
MIELE TYPE G/H/N MODELS
- S5 SERIES, S230 SERIES,
S280 SERIES, S400 SERIES,
S600 SERIES, S800 SERIES,
S5000 SERIES MODELS WITH
4 WHEELS - **BAG**



U055

PAPER BAG - PACK OF 5
MIELE VACUUM CLEANER -
S230i, S240i, S272i, S277i,
S278i, S227i, S229i



U174

PAPER BAG - PACK OF 5
MIELE VACUUM CLEANER
S180, S182, S200, S204



NILCO

U055

PAPER BAG - PACK OF 10
NILCO VACUUM CLEANER- 171,
271



U076

PAPER BAG - PACK OF 5
NILCO VACUUM CLEANER -
1107, 1207, 1407



NUMATIC

U055

NUMATIC ORIGINAL NVM2B2
P/BAG - PACK OF 10
NUMATIC - CHARLES CVC370-2,
GEORGE GVE370-2, HZQ250-
2, HZQ200-2, HZQ370-2,
MFQ370-22, NQS350B-22,
NRV370-22, NRV380-22,
NVP370-2, NVQ370-22,
NVQ380-22, WV370-2,
WV380-2



U210

HEPAFLO BAG NVM-1CH -
PACK 10
NUMATIC - JAMES JVP180,
HENRY MICRO HVR200M,
HENRY TURBO HVR200T,
HENRY XTRA HVX200,
HZQ250, NQS250B,
NRV200T, NVP180-2,
NVQ200, HENRY HVR200A,
HETTY HET200A



U220

PAPER BAG - PACK OF 10
U200 replacement for
NUMATIC - CHARLES
CVC370-2, GEORGE
GVE370-2, HZQ250-2,
HZQ200-2, HZQ370-2,
MFQ370-22, NQS350B-22,
NRV370-22, NRV380-22,
NVP370-2, NVQ370-22,
NVQ380-22, WV370-2,
WV380-2



U230

PAPER BAG SINGLE LAYER -
PACK OF 10
NUMATIC NVM3B
replacement - suitable for
: HZQ370-2, HZQ750-2,
NVDQ570-2, WV570-2,
HZDQ750-2, NVQ570-22,
WVD570-2



U240

PAPER BAG - PACK OF 10
NUMATIC NVM4B replacement
- suitable for NV750, NTD750-
2, NTD750C-2, NTD750M-2,
NVQ900-22, TPD930, WV900-
2, WVD900-2, WVD750T-2,
HZDQ750-2, TPD570



PANASONIC



U063

**PAPER BAG - PACK OF 5
PANASONIC VACUUM CLEANER
- ALL CYLINDER MODELS**



U095

**PAPER BAG - PACK OF 5
PANASONIC VACUUM
CLEANER - ALL UPRIGHT
MODELS**

PHILIPS



HC 843

**PAPER BAG - PACK OF 5
PHILIPS VACUUM CLEANER -
HL3636, HL3686, HL3687
ALT: HC 843**

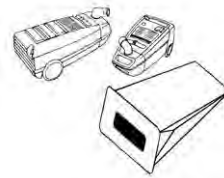

U018

**PAPER BAG - PACK OF 5
PHILIPS VACUUM CLEANER -
HR6215, HR6242, HR6255,
HR6256, HR6259, HR6270,
HR6279, HR6299, P42, P59,
P70, P79**



U032

**PAPER BAG - PACK OF 10
PHILIPS VACUUM CLEANER -
HL3650**



U058

**PAPER BAG - PACK OF 10
PHILIPS VACUUM CLEANER -
HL3636, HL3686, HL3687**



U098

**PAPER BAG - PACK OF 5
PHILIPS VACUUM CLEANER
- HR6300 THRU HR6580,
HR6700, HR6780, HR6938,
P700, P780, T300, T360, T520,
T720**

PROGRESS



HC 990

**PAPER BAG - PACK OF 5
PROGRESS 1300, LG TURBO
BETA & TURBO S
NEW**

ROWENTA



HC 843

**PAPER BAG - PACK OF 5
ROWENTA DYMBO, ZR745,
RS005, RS007, RS0085, RS009
NEW**

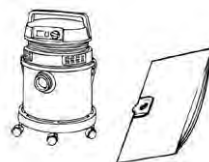

U043

**PAPER BAG - PACK OF 5
ROWENTA VACUUM
CLEANER - RU33, RU42,
RU43, RU44**



U045

PAPER BAG - PACK OF 5
ROWENTA VACUUM
CLEANER - RB01, RB02,
RB12, RB13, RB15, RB16,
RB18, RB19, RB21, RB22,
RB23, RB24, RB33, ZR76



U071

PAPER BAG - PACK OF 5
ROWENTA VACUUM
CLEANER - RB50, RB51,
RB52, RU01, RU05, RU10,
RU11



SEBO

U047

PAPER BAG - PACK OF 5
SEBO VACUUM CLEANER - 350,
360, 460



SIEMENS

U034

PAPER BAG - PACK OF 5
SIEMENS VACUUM CLEANER
- VS30, VS32, VS38, VS64,
VS68, VS69

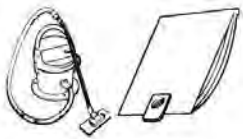

SORMA

U022

PAPER BAG - PACK OF 5
SORMA VACUUM CLEANER -
115



TASKI

U022

PAPER BAG - PACK OF 5
TASKI VACUUM CLEANER -
BABY BORA



TEDELEK

U063

PAPER BAG - PACK OF 5
TEDELEX VACUUM CLEANER -
1400, 1450

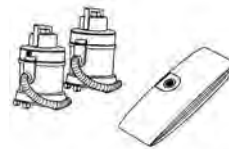

VAX

U117

PAPER BAG - PACK OF 5
VAX VACUUM CLEANER - 101,
2000 WET & DRY



VICTOR

U076

PAPER BAG - PACK OF 5
VICTOR VACUUM CLEANER -
1207



VORWERK



HC 194

PAPER BAG - PACK OF 5
VORWERK VACUUM CLEANER
- ET31, ET340, VK118, VK120,
VK121, VK122
ALT: U087



HC 294

PAPER BAG - PACK OF 5
VORWERK VACUUM
CLEANER - ET3, ET4, ET10,
ET20, ET21, ET30, VK117,
VK119



U021

PAPER BAG - PACK OF 5
VORWERK VACUUM CLEANER
- ET3, ET4, ET10, ET20, ET21,
ET30, VK117, VK119



U087

PAPER BAG - PACK OF 5
VORWERK VACUUM
CLEANER - ET31, ET340,
VK118, VK120, VK121,
VK122

WAP



HC 640

PAPER BAG - SINGLE
WAP XL & XLS
BAG



HC 645

WOVEN BAG3 -
PACK OF 3
WAP AERO 640, AERO 300
BAG



HC 819

PAPER BAG - PACK OF 5
ELECTROLUX VACUUM
CLEANER - Z330, Z345



HC 824

WOVEN BAGS -
PACK OF 3
WAP AERO 25, AERO 20
INOX
BAG



HC 825

PAPER BAG - PACK OF 3
WAP ALTO ATTIX 3
BAG



HC 827

WOVEN BAGS -
PACK OF 3
WAP ATTIX 3
BAG



U450

PAPER BAG - SINGLE BAG
WAP VACUUM CLEANER -
SQ400, SQ450/01



U640

PAPER BAG - PACK OF 3
WAP VACUUM CLEANER -
AERO 640



U804

PAPER BAG - PACK OF 3
WAP VACUUM CLEANER -
VS300



U819

PAPER BAG - SINGLE BAG
WAP VACUUM CLEANER - XL,
XLS



U821

**PAPER BAG - PACK OF 3
WAP VACUUM CLEANER -
AERO 300**



HC 025

**PAPER BAG-PACK OF 5
HOOVER V/CLEANER -
CV025**



HC 056

**PAPER BAG - PACK OF
ELECTROLUX ULTIMA
5005/6/4602**



HC 330

**PAPER BAG - PACK OF
HOOVER - UV330**



HC 740

**PAPER BAG - PACK OF
SAMSUNG -
VC6013/7715/7400**



HC 823

**PAPER BAG - PACK OF
BOSCH - BMS1000**



HC 828

**PAPER BAG - PACK OF
KARCHER WET & DRY A2054**

BELTS





▶ BELTS: FLAT, ROUND, GROOVED

▶ BMB2	DRIVE BELT - ROUND	HOOVER VACUUM CLEANER - JUNIOR: 1334, 1338, 1346, 1358, 1358A, U1012, U1014, U1018, U1098, U2172
▶ BMB5	DRIVE BELT - ROUND	HOOVER VACUUM CLEANER - SENIOR 652 SERIES, U4006, U4016, U4082, U4208, U4304, U4306, U7010
▶ FBA05	POWE DRIVE BELT - FLAT	HOOVER VACUUM CLEANER - CONCEPT 1: U3101, U4203, U4205, U4324
▶ FBA06	MAIN DRIVE BELT - FLAT	HOOVER VACUUM CLEANER - CONCEPT U3101, U4203, U4205, U4324, U6331; ELECTROLUX VACUUM CLEANER - GLIDER SERIES
▶ FBA07	DRIVE BELT - FLAT	HOOVER VACUUM CLEANER - JUNIOR: U1124, U1127, U1128
▶ FBA09	DRIVE BELT - FLAT	VORWERK VACUUM CLEANER - ET20, VK117
▶ FBA12	DRIVE BELT - FLAT	ELECTROLUX VACUUM CLEANER - Z500, Z502, Z504, Z506, Z506E, Z522, Z550, Z560
▶ FBA13	DRIVE BELT - FLAT	ELECTROLUX VACUUM CLEANER - 610, 612, 612E, 912; HOOVER VACUUM CLEANER - C1413, U5065, U5433
▶ FBA14	DRIVE BELT - FLAT	HOOVER VACUUM CLEANER - U1202
▶ FBA15	DRIVE BELT - FLAT	HOOVER VACUUM CLEANER - TURBOPOWER 1: U1100, U1220, U1284, U1294, U1412, U2194, U2198, U2332, U2336, U2558, U2604, U2684, U2684D, U2716, U2795, U2796; LG VACUUM CLEANERS - V-UP861NB, V-UP881NB
▶ FBA16	DRIVE BELT - FLAT	HITACHI VACUUM CLEANER - CV50D, CV60D, CV770D; HOOVER VACUUM CLEANER - TURBOPOWER 2: U2462, U2464, TURBOPOWER 3: U2806, U2812, U2878; NATIONAL VACUUM CLEANER - MC663
▶ FBA17	DRIVE BELT - FLAT	KIRBY VACUUM CLEANER - HERATIGE, TRADITION, GENERATION 3 & 4
▶ FBA18	POWER DRIVE BELT - FLAT	HOOVER VACUUM CLEANER - TURBOMASTER : U5094
▶ FBA21	DRIVE BELT - FLAT	PHILIPS VACUUM CLEANER - HL3636, HL3650, HL3686, HL3687
▶ FBA23	DRIVE BELT - FLAT	PANASONIC VACUUM CLEANER - ALL UPRIGHT MODELS
▶ LG-4400FI3348A	DRIVE BELT - FLAT	LG VACUUM CLEANERS - V-UP142NJP
▶ LUX61503	DRIVE BELT - FLAT	ELECTROLUX - Z1360, Z1480, Z1484, Z2905, Z2915, Z3276, Z4702, Z4705

BRUSHES: AGITATOR, BRISTLES, WAX, DISCS



COL3019

BUFFING PAD - PAIR
COLUMBUS POLISHER
- SP737, SP747, SP757,
SP767 ELECTROLUX
POLISHER: ES400, 400SLC,
450SLC, 460SLC, 500SLC,
600SLC, 700SLC
ORIGINAL PART



CCB425

BLACK STRIPPING PAD
425MM
universal application

CCB500

BLACK STRIPPING PAD
500MM
universal application

CCR425

RED BUFFING PAD 425MM
universal application

CCR500

RED BUFFING PAD 500MM
universal application

CCW425

WHITE POLISHING PAD 425MM
universal application

CCW500

WHITE POLISHING PAD
500MM
universal application



COL3043
BUFFING PAD RETAINING SPINDLE
 COLUMBUS POLISHER - SP737, SP747, SP757, SP767
 ELECTROLUX POLISHER: ES400, 400SLC, 450SLC, 460SLC, 500SLC, 600SLC, 700SLC
ORIGINAL PART



COL3071
BRUSH RETAINING SPINDLE KIT
 COLUMBUS POLISHER - SP737, SP747, SP757, SP767
ORIGINAL PART



HSB 14
SHAMPOO BRUSH - PAIR
 COLUMBUS POLISHER - SP737, SP747, SP757, SP767
 ELECTROLUX POLISHER: ES400, 400SLC, 450SLC, 460SLC, 500SLC, 600SLC, 700SLC
ORIGINAL PART



HSB 15
POLISH BRUSH - PAIR
 COLUMBUS POLISHER - SP737, SP747, SP757, SP767
 ELECTROLUX POLISHER: ES400, 400SLC, 450SLC, 460SLC, 500SLC, 600SLC, 700SLC
ORIGINAL PART



HSB 73
POLISH BRUSH - PAIR
 HOOVER POLISHER - F2004, F2008, F2162, F4002, F4164, F4192, F4358, F4358E, F4358W, F4366, F4404



HSB 74
SHAMPOO BRUSH - PAIR
 HOOVER POLISHER - F2004, F2008, F2162, F4002, F4164, F4192, F4358, F4358E, F4358W, F4366, F4404

CARBON BRUSHES: PAIRS, HOLDERS



VC52
CARBON BRUSH - PAIR 6mm x 9mm x 25,5mm
 ELECTROLUX vacuum cleaner - all 'Z' series



VC150
CARBON BRUSH - PAIR 4,5mm x 5,5mm x 14,2mm
 VORWERK vacuum cleaner - ET20, ET30, ET31, ET340



VC154
CARBON BRUSH - PAIR 6,3mm x 11mm x 25,6mm
 universal application
 ROWENTA vacuum cleaner - most models



VC157
CARBON BRUSH - PAIR 6,2mm x 9,5mm x 26,3mm
 HOOVER vacuum cleaner - SENSOTRONIC: S3128, S3134, S3150, S4350
 Suitable with UX6 motor



VC180
CARBON BRUSH - PAIR 6mm x 8mm
 FITS UX11 MOTOR

▼ FILTERS: CARTRIDGE, CLOTH, EXHAUST



▼ FLT21

CARTRIDGE FILTER
AQUAVAC vacuum cleaner -
wet & dry early



▼ FLT23

CARTRIDGE FILTER
ROWENTA vacuum cleaner -
all wet & dry models



▼ FLT25

CARTRIDGE FILTER
WAP vacuum cleaner - XL, XLS



▼ FLT32

CARTRIDGE FILTER
WAP vacuum cleaner - PET,
TURBO GT, TURBO GT5



▼ LUX-A109001

HEPA FILTER
ELECTROLUX Vacuum Cleaner
VIVA SPIN7480



▼ LUX-A4080010004R

MOTOR FILTER
ELECTROLUX Vacuum Cleaner
Z1860, LITE11



▼ LUX-3L24218-H-YOR

HEPA FILTER + MESH
ELECTROLUX Vacuum Cleaner
ZSH720, CYCLONE POWER



▼ LUX-9001951194

HEPA FILTER
ELECTROLUX Vacuum Cleaner
WASHABLE, AE05410, AJG6800 /
ASC 6940



▼ FLT22

CARTRIDGE FILTER
ELECTROLUX vacuum
cleaner - HURRICANE: 2000,
3000



▼ FLT24

CARTRIDGE FILTER
WAP vacuum cleaner - M1,
M2, TURBO'D'



▼ FLT29

FOAM FILTER
AQUAVAC vacuum cleaner -
wet & dry late



▼ LUX-A248001005R

HEPA FILTER
ELECTROLUX Vacuum Cleaner
Z7310 CYCLON ULTRA



▼ LUX-A3570010001R

MOTOR FILTER
ELECTROLUX Vacuum Cleaner
TORNADO A04009



▼ LUX-39524

HEPA FILTER
ELECTROLUX Vacuum Cleaner
POWER GLIDE PET, Z3276AZ



▼ LUX-82366A-1

FILTER ASSEMBLY
ELECTROLUX Vacuum Cleaner
Z3276AZ, POWER GLIDE PET



HOSES: ASSEMBLIES, ENDS, PARTS



CRT7

35MM CREVICE TOOL
Suitable for wap& bosch vacuum cleaners



CRT9

UNIVERSAL CREVICE TOOL
32mm - BLACK
AQUAVAC - late models;
ELECTROLUX, ROWENTA
- most models; HOOVER -
TURBOPOWER series



EXR08

UNIVERSAL EXTENSION ROD
32mm - BLACK
AQUAVAC - late models;
ELECTROLUX, ROWENTA
- most models; HOOVER -
TURBOPOWER series



EXR10

32mm EXTENSION ROD - STAINLESS STEEL
NUMATIC - JAMES JVP180, HENRY MICRO HVR200M, HENRY TURBO HVR200T, HENRY XTRA HVX200, HZQ250, NQS250B, NRV200T, NVP180-2, NVQ200, HENRY HVR200A, HETTY HET200A



EXR12

UNIVERSAL EXTENSION ROD
35mm
SUITABLE FOR WAP DOMESTIC VACUUM CLEANERS



EXR20

PIPPED EXTENSION ROD - BLACK
HOOVER vacuum cleaner
- AQUAPLUS 1700 series,
AQUAPLUS 2200 series,
AQUAMASTER SERIES, early
upright and cylinder models



EXR34

CRUSHPROOF HOSE BENT END
32mm - BLACK
AQUAVAC - late models;
ELECTROLUX, ROWENTA
- most models; HOOVER -
TURBOPOWER series



EXR35

PIPPED CRUSHPROOF HOSE BENT END - BLACK
HOOVER vacuum cleaner
- AQUAPLUS 1700 series,
AQUAPLUS 2200 series, early
upright and cylinder models



EXR43

PAPER BAG - PACK OF 5
ELECTROLUX VACUUM
CLEANER - COMMERCIAL
CANISTER : Z925



HDB2

PIPPED DUSTING BRUSH - BLACK
HOOVER vacuum cleaner
- AQUAPLUS 1700 series,
AQUAPLUS 2200 series,
AQUAMASTER series, early
upright and cylinder models



HE15

CRUSHPROOF HOSE CUFF - BLACK
Suitable with 32mm hose



HE12

HOSE END SEAL RING
Used with part: HE30



HE17

CRUSHPROOF HOSE CUFF - BLACK
Suitable with 38mm hose



HE19

CRUSHPROOF HOSE CUFF - 36mm
Fits most wap vacuum cleaners



HE21

MACHINE END
WAP vacuum cleaners - XL, XLS



HE23

32MM MACHINE END
Suitable for WAP domestic vacuum cleaners



HE26

HOSE SCREW CUFF
Suitable with 32mm crushproof hose



HE43

CRUSHPROOF HOSE SCREW MACHINE END - BLACK
HOOVER vacuum cleaner - AQUAPLUS 1700 series, AQUAPLUS 2200 series, AQUAMASTER series



MCT08

COMBINATION FLOOR BRUSH DE LUXE QUALITY - BLACK
Suitable with AQUAVAC early, CONTI, ELECTROLUX; HOOVER ZW1200 & TURBOPOWER series, ROWENTA - all models



MCT15

COMBINATION FLOOR BRUSH DE LUXE QUALITY - BLACK
AEG vacuum cleaner - all VAMPYR models



LG-5215FI1306R

VACUUM HOSE ASSEMBLY
LG vacuum - V-CP243NDR



HE22

CRUSHPROOF HOSE MACHINE END - BLACK
AQUAVAC vacuum cleaner - wet & dry models
ROWENTA vacuum cleaner - all wet & dry models



HE25

CLICK RING - BLACK
Suitable with 32mm crushproof hose



HE30

CRUSHPROOF HOSE 3 LUG MACHINE END - BLACK
ELECTROLUX vacuum cleaner - all wet & dry models



MCT04

COMBINATION FLOOR BRUSH - BLACK
HOOVER vacuum cleaner - AQUAPLUS 1700 series, AQUAPLUS 2200 series, AQUAMASTER series, early upright and cylinder models



MCT12

UNIVERSAL COMBINATION FLOOR BRUSH 35mm - BLACK
Suitable with WAP domestic vacuum cleaners



MCT20

COMBINATION FLOOR BRUSH DE LUXE QUALITY - BLACK
Suitable with extension rods: 28mm thru 40mm bore universal application



LUX-A000202H015R

HOSE ASSEMBLY
ELECTROLUX MODELS: Z7310 CYCLONE ULTRA



LG-5215FI1367B

Hose Assembly, Flexible
LG vacuum - V-CP963ST,
VTCP243ND



LUX-13354000

HOSE ASSEMBLY
ELECTROLUX MODELS:
A2008, A2011, A2015,
A2017



LUX-2193713 - 01/9

HOSE ASSEMBLY
ELECTROLUX MODELS:
AUPG3801, AUO882OP



LUX500514

HOSE ASSEMBLY
ELECTROLUX MODELS:
H5005 - ULTIMA



LUX-74095-5

HOSE ASSEMBLY
ELECTROLUX MODELS:
Z3276, POWER GLIDE



VH02

HOSE ASSEMBLY - BLACK
AQUAVAC vacuum cleaner -
wet & dry early



VH16

HOSE ASSEMBLY - BLACK
AEG vacuum cleaner - all
VAMPYR models



VH30

**32mm CRUSHPROOF VAC
HOSE - BLACK**
1,8 metre length



VH34

HOSE ASSEMBLY - BLACK
AQUAVAC/AQUALUX vacuum
cleaner - wet & dry early
ELECTROLUX vacuum cleaner
- all wet & dry models, Z300
series, SLIMLINE series



VH35

HOSE ASSEMBLY - BLACK
FITS WAP models - XL & XLS



VH36

**36mm CRUSHPROOF VAC HOSE -
BLACK**
12 metre roll



VH37

HOSE ASSEMBLY - BLACK
WAP vacuum cleaners - 330,
440, 640



VH38

**38mm CRUSHPROOF VAC HOS
- BLACK**
12 metre roll



VH42

HOSE ASSEMBLY - BLACK
HOOVER vacuum cleaners -
S4440



VH45

32mm CRUSHPROOF VAC HOSE - BLACK
10 metre roll



VH50

50mm CRUSHPROOF VAC HOSE - BLACK
20 metre roll



VRS2

LITTER PICKER, 32mm



VRS7

LITTER PICKER - 35mm
suitable with WAP domestic vacuum cleaners

MOTORS: COMPLETE, PARTS



UX-CONE

FAN HOUSING WITH CONE
suitable for part: UX6



UX11

SINGLE STAGE MOTOR
HITACHI vacuum cleaner - CV2500



UX17

UNV. 3 STAGE MOTOR - 24 Volt
wet & dry suction - commercial application



UX18

UNV. 3 STAGE MOTOR - 36 Volt
wet & dry suction - commercial application



UX19

UNV. 3 STAGE MOTOR - 24 Volt
TANGENTIAL motor - commercial application



UX20

UNV. 3 STAGE MOTOR - 36 Volt
TANGENTIAL motor - commercial application



UX2B

1400W DOUBLE STAGE MOTOR - WITH MOUNTING HOLES
wet & dry suction (by-pass)



UX2C

1200W DOUBLE STAGE MOTOR
WET & DRY SUCTION (BY-PASS)



UX4

1000W DOUBLE STAGE MOTOR
dry suction (thru-flow) AEG vacuum cleaner - all VAMPYR & compact models also fits MIELE, NUMATIC, WETROK and others



UX5

1400W DOUBLE STAGE MOTOR
WET & DRY SUCTION (BY-PASS)



UX5B

1000W SINGLE STAGE MOTOR - WITH MOUNTING HOLES
Wet & dry suction (by-pass)



UX5C

1000W DOUBLE STAGE MOTOR
WET & DRY SUCTION (BY-PASS)



UX6

1200W TANGENTIAL DOUBLE STAGE MOTOR
loop suction suitable with WAP commercial cannisters and other commercial suction cleaning systems



UX6C

1200W TANGENTIAL DOUBLE STAGE MOTOR
TANGENTIAL DISCHARGE MOTOR



UX8

1200W SINGLE STAGE MOTOR
SUITABLE FOR NUMATIC VACUUM CLEANERS

SWITCHES: FOOT, MAINS



HDS650

2 POLE ON/OFF SWITCH
Non-illuminated - black



HDS700

ILLUMINATED DOUBLE POLE ON/OFF SWITCH
HOOVER vacuum cleaner - S4488 WET & DRY; suitable with many other canister vacuum cleaners



SRR3

ILLUMINATED MINI ON/OFF SWITCH
suitable with many upright vacuum cleaners



SW12

ON/OFF SWITCH
ELECTROLUX vacuum cleaner - HURRICANE





SW16

**NON ILLUMINATED MINI ON/
OFF SWITCH**
COLUMBUS POLISHER - B11,
B12; ELECTROLUX POLISHER
- ES400, 400SLC, 450SLC,
460SLC, 500SLC, 600SLC,
700SLC



SW29

**ROCKER SWITCH ROUND -
RED**
UNIVERSAL APPLICATION

TANKS: CAPS, FEED HOSES, PARTS



COL10025

DISPENSER VALVE CAP
ELECTROLUX POLISHER -
ES400, 400SLC, 450SLC,
460SLC, 500SLC, 600SLC,
700SLC
ORIGINAL PART



03



STOVES & COOKERS



CLEANING AGENTS



HM 69

HILLMARK CERASEAL 250ml
Suitable for all ceramic tops



HM 84

HILLMARK CERAPOL
Suitable for all ceramic tops



HM 85

TIARA STAINLESS STEEL CLEANER
Suitable for all stainless steel surfaces. Removes rust & stains.



HM 90

HILLMARK STEELKLEEN
Suitable for all stainless steel surfaces



SCH-SCR

HOB SCRAPER
suitable for use on all ceramic hobs - includes spare blade



SSC01

'COLLO' SOLID PLATE CLEANER POLISH
suitable for all solid stove plates



HM70

SCALE X PLUS CLEANER
3 X 75g



HM67

HILLMARK EXPRESSOR CLEAN



HM85

TIARA
85g
STAINLESS STEEL CLEANER



HM74

STONE KLEEN & PROTECT
375ml

COOKERHOOD: FILTERS



4819 480 48221

GREASE FILTER x 2
470mm x 570mm - universal application



SCHF1

CHARCOAL FILTER
DEFY cookerhood - all 600mm and 900mm models

COOKERHOOD: GLASS



D26702

GREY VISARD GLASS -
900mm LONG
DEFY cookerhood - all 900mm models - can be cut shorter for 600mm models
ORIGINAL PART



DSY0503B

LATERAL R/H D GLASS -
DCH 290-5



DSY0504B

HOLDER LATERAL -
R/H DCH 290-5

COOKERHOOD: PARTS



SW14WF

**CENTRE-OFF TWO WAY
ROCKER SWITCH**
suitable with most makes of cookerhoods - early



DSY0509D

ROUND CARBON FILTER -
600 / 750 / 900
NEW LEVEL DCH290 -
DCH296



SFLT900

**WOVEN UNIVERSAL GREASE
FILTER**
400 x 900mm - can be cut to size



DSY0503

LATERAL L/H D GLASS -
DCH 290-5



DSY0504

HOLDER LATERAL -
L/H DCH 290-5



SWCHLM

**C/HOOD CONTROL
ASSEMBLY**
fits most locally
manufactured cookerhoods



OVEN DOOR SEAL MATRIX



SDSD22

580 X 355MM
3 SIDED - DEFY 424, HOSTESS, VOGUE

SDSD25

520 X 400MM
4 SIDED - DEFY GEMINI EYE LEVEL LARGE OVEN

SDSD26

520 X 315MM
4 SIDED - DEFY GEMINI EYE LEVEL SMALL OVEN

SDSD29

470 X 375MM
3 SIDED - 119, 319, 419, 511, 610, 611, 620, 621, 631, 635, 641, 655, 660, KITCHENAIRE CMT3/4

SDSD30

540 X 375MM
3 SIDED - 422, 710, 711, 720, 721, 731, 741, 765, 770, 771, KITCHENMASTER 550

DOORS: CATCHES, HANDLES, STRIKERS



BC450623

DOOR CATCH
KELVINATOR stove - all 'B' series eye-level ovens
ORIGINAL PART



D28720WS

DOOR HANDLE - WHITE
DEFY SLIMLINE 600 series
ORIGINAL PART



D621133

DOOR HANDLE END - BOTTOM
DEFY GEMINI ovens - early



D61644

DOOR HANDLE
SLIMLINE oven door
DB0315 / 457 / DSS406 / 71 / 455



D28720

DOOR HANDLE KIT - BLACK
DEFY stove - SERIES 600
FREE STANDING STOVE
ORIGINAL PART



D615789

DOOR STRIKER PIN
DEFY stove - all GEMINI eye-level and undercounter ovens
ORIGINAL PART



D621134

DOOR HANDLE END - TOP
DEFY GEMINI ovens - early



D6698

DOOR ROLLER CATCH
DEFY stove - all GEMINI eye-level and undercounter ovens
ORIGINAL PART

DOORS: HINGES & PARTS



4819 417 19147

HINGE ASSEMBLY.
KIC stove - all 'UCC' models;
WHIRLPOOL - AKG310
ORIGINAL PART



D63578

HINGE ASSEMBLY.
DEFY SLIMLINE series



D7781

LINK BAR PIN
DEFY stove - 116, 118, 316,
416, 418, 420, 424, ALLIED,
VOGUE, CADETTE, HOSTESS,
MAJORETTER, SPACESAVER,
SUPER TWENTY **ORIGINAL PART**



SDH04

HINGE MECHANISM
DEFY stove - 422, 710,
711, 720, 721, 731, 735,
741, 765, 770, 771,
KITCHENMASTER 550



SDH08

HINGE MECHANISM
UNIVA stove - 631B, 631W,
G014, G114, 611
OEM REF: 5704600



SDH11

HINGE MECHANISM
FUCHSWARE stove - ST61,
GT76, ST76; UNIVA STOVE -
204AR, 718, 813, 814



SDH15

HINGE RHS - YELLOW
UNIVA stoves; KIC - KC625
OEM REF: 0333L



BC451270

HINGE COMPLETE
KELVINATOR stove - all 'B'
series eye-level ovens
ORIGINAL PART



D6970

HINGE LINK BAR
DEFY stove - 116, 118, 316, 416,
418, 420, 424, ALLIED, VOGUE,
CADETTE, HOSTESS, MAJORETTER,
SPACESAVER, SUPER TWENTY
ORIGINAL PART



SDH03

HINGE MECHANISM
DEFY stove - 119, 319, 419,
610, 611, 620, 621, 631,
641, 655, 660, KITCHENAIRE,
CMT4



SDH05

HINGE MECHANISM
DEFY stove - 425, 831, 835



SDH09

HINGE SUPPORT
UNIVA stove - 501, 502, 611,
631B, 631W, G001, G014,
G114. ALL DEFY SLIMLINE
OVENS
OEM REF: 5704700



SDH14

HINGE RHS - YELLOW
UNIVA stoves; KIC - KC625
OEM REF: 0326D



DOORS: SEALS



SDS3

UNIVERSAL THREE SIDED OVEN DOOR SEAL KIT
Includes two corner & two end hooks



SDS4

UNIVERSAL FOUR SIDED OVEN DOOR SEAL KIT
Includes four corner hooks



SDS10

UNIVERSAL OVEN DOOR SEAL - 10 METRES
Excluding end & corner hooks



SDSHKC

CORNER HOOK - PACK OF 10
Suitable with part number: SDS10



SDSHKS

STRAIGHT END HOOK - PACK OF 10
Suitable with part number: SDS10

ELEMENTS: BAKE, GRILL, WARMER

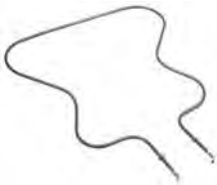

SBEA53

BAKE ELEMENT - 1500W
AEG stove - EBO 2011

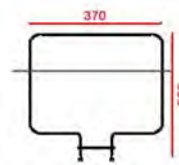

SBEB32

BAKE ELEMENT KELVINATOR STOVE - "B" SERIES
OEM REF: K00391

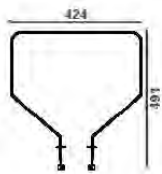

SBEB50

BAKE ELEMENT - 1800W
KELVINATOR - PRINCESS P25



SBEB51

BAKE ELEMENT - 2600W
KELVINATOR - COOKERAMA C30



SBEB52

BAKE ELEMENT - 2000W
KELVINATOR - DE VILLE : B105, B205, B305,
FREESTANDING: SA135, SA145, SA245, SB345, S535, S645, S735, S745

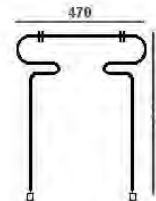

SBEB53

BAKE ELEMENT - 1600W
KELVINATOR - G547, S547, S847



SBEB54

BAKE ELEMENT - 1600W
KELVINATOR - S545, S845



SBEB55

BAKE ELEMENT - 2500W
FUCHSWARE stove - H8, HC3



SBEB56

BAKE ELEMENT - 2200W
FUCHSWARE stove - CD4,
M4, M4R



SBEB57

BAKE ELEMENT - 1400W
PREMIER 30 stove



SBEB60

BAKE ELEMENT - 1800W
KELVINATOR - B4610,
B4700, B5610, B5620,
B5700, B6610, B6620

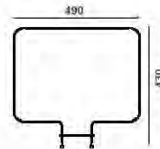

SBEB61

BAKE ELEMENT - 2200W
FRIGIDAIRE stove - ORD39C



SBEB62

BAKE ELEMENT - 2200W
FUCHSWARE stove -
PREMIER 30, ST61

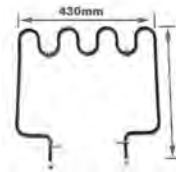

SBED64

DEFY BAKE OVEN ELEMENT
1900W



SBED67

BAKE ELEMENT - 2200W
DEFY PETIT CHEF



SBED68

BAKE ELEMENT - 1500W
DEFY stove - 501, 511, 520,
521, 531 SLIMLINE 600
EARLY series (excluding
thermofan models)



SBED69

BAKE ELEMENT - 1500W
DEFY 560 SERIES FREE
STANDING STOVES

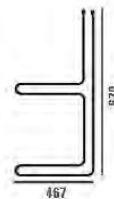

SBED70

BAKE ELEMENT - 3500W
DEFY RAYBURN E12



SBED71

BAKE ELEMENT - 1600W
DEFY ALLIED, CADETTE 3,
CADETTE 4



SBED72

BAKE ELEMENT - 2000W
DEFY VOGUE, HOSTESS, 422,
424 (SILVER 70'S)



SBED73

BAKE ELEMENT - 1800W
DEFY space saver, 500 eye-
level, 550 wall unit; GEMINI
eye-level, 420 MK1



SBED74

BAKE ELEMENT - 1800W
DEFY 418 plug-in, 418
ROTISSERIE, MAJORETTE,
118, CADETTE



SBED75

ELEMENT, BAKE DEFY
OEM REF: 028420
065211



SBED76

BAKE ELEMENT - 2200W
DEFY 550, 420,
KITCHENMASTER



SBED77

BAKE ELEMENT - 2200W
DEFY GEMINI, GOURMET,
550 double oven



SBED78

ELEMENT, BAKE 1800W
GEMINI
OEM REF: 028420



SBED79

ELEMENT, BAKE DEFY 600
SERIES FREE STANDING
STOVE SLIMLINE
UNDERCOVER OVEN



SBED80

BAKE ELEMENT - 2500W
DEFY 425, 425 smooth top,
426



SBED81

BAKE ELEMENT - 2200W
DEFY 422 solid, 422 DE
LUXE, 422CC



SBED84

BAKE ELEMENT - 1900W
DEFY 119 plug-in, 410 STD,
KITCHENAIRE, 419



SBED85

BAKE ELEMENT - 1600W
DEFY MAJOR MK6, 316, 416,
116



SBED90

BAKE ELEMENT - 2500W
DEFY 424, 424 self clean,
smooth top



SBED91

BAKE ELEMENT
DEFY GAS STOVE
DGS 154 / 155
OEM REF: 606094

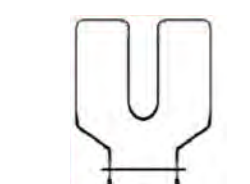

SBEJ42

BAKE ELEMENT - 1000W
Fits JUNKER RUH stoves



SBEK40

BAKE ELEMENT - 2000W
KIC stoves FSB400 series



SBEK41

BAKE ELEMENT - 1150W
KIC UCC & ELD models



SBEK42

ELEMENT, BAKE W/POOL
700W



SBEK44

BAKE ELEMENT - 2000W
KIC EYE-LEVEL OVENS



SBES32

BAKE ELEMENT
SAMET oven - NE3F
OEM REF: 1170000008

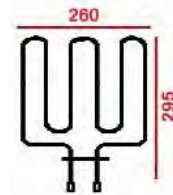

SBES34

BAKE ELEMENT - 2200W
SAMET OVEN - 4455E4

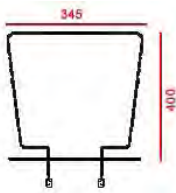

SBEW31

BAKE ELEMENT - 1000W
SUITABLE FOR WHIRLPOOL
AKP503
OEM REF: 4819 259 28791

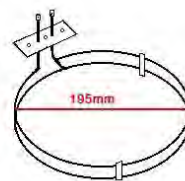

SFEA82

THERMOFAN ELEMENT -
2200W
AEG STOVE - B220



SFEB81

THERMOFAN ELEMENT -
2000W
KELVINATOR stove - SF845,
S847

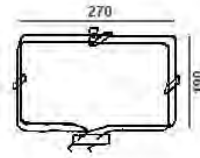

SFEB85

THERMOFAN ELEMENT -
2500W
KELVINATOR stove - all late
models

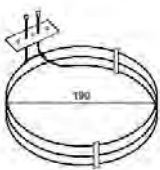

SFED86

THERMOFAN ELEMENT -
2800W
DEFY stove - 418, 420, 422,
424, 641, 655, 731; GEMINI
eye-level



SFED87

THERMOFAN ELEMENT -
3400W
DEFY stove 425, 835 dual



SFED88

THERMOFAN ELEMENT -
2150W
DEFY SLIMLINE



SFES89

THERMOFAN ELEMENT -
3700W
SAMET THERMOFAN OVENS



SGEB106

GRILL ELEMENT - 1100W +
1100W
KELVINATOR - B4610,
B4700, B5610, B5620,
B5700, B6610, B6620



SGEB107

GRILL ELEMENT - 1500W
KELVINATOR - P11, P12



SGEB57

GRILL ELEMENT - 1900W + 600W
FUCHSWARE - BOU76, HC3LH, HC3RH, PREMIER 30, ST61

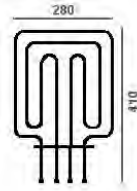

SGEB58

GRILL ELEMENT- 300W + 200W
FUCHSWARE - BOU1 eye-level, L3, L4



SGEB59

GRILL ELEMENT - 2000W
FUCHSWARE - H401

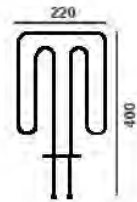

SGEB60

GRILL ELEMENT - 2000W
FUCHSWARE - H401



SGEB61

GRILL ELEMENT - 2000W
KELVINATOR PRINCESS

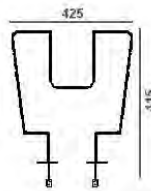

SGEB62

GRILL ELEMENT - 1900W
KELVINATOR - B4710

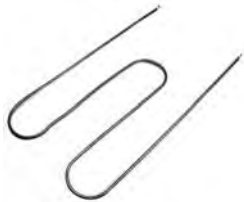

SGEB89

GRILL ELEMENT - 2000W
KELVINATOR DE VILLE - B105, B205, B305, freestanding: SA135, SA145, SA245, SB345, S535, S545, S547, S645, S735, S745, S845, S847



SGED66

GRILL ELEMENT- 2800W
DEFY - GOURMET, MULTICHEF
OEM REF: 028410



SGED81

GRILL ELEMENT - 1800W
DEFY - 611S, 621 ADVANCED, 621 CONCEPT, 621 GALA DELUXE, 621 EXECUTIVE, 622 HERITAGE OEM REF: 028435



SGED83

GRILL ELEMENT- 1300W
DEFY - 119 plug-in



SGED84

GRILL ELEMENT- 300W + 2200W
DEFY GEMINI PETIT CHEF eye-level; UNIVA stove - 611, 621B, 621W, 631B, 631W



SGED85

GRILL ELEMENT - 2500W
DEFY RAYBURN - E12

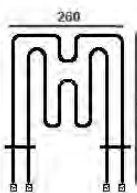

SGED86

GRILL ELEMENT - 300W + 2000W
DEFY ALLIED



SGED87

GRILL ELEMENT- 2200W
DEFY GEMINI - late models



SGED88

GRILL ELEMENT - 1200W
DEFY PETIT CHEF 2
DEFY 500 SERIES



SGED90

GRILL ELEMENT - 180w
DEFY - 600, 700, GEMINI, PETIT
CHEF, GORDRON BLEU
7115, 631T, 731 GOLD, 731T,
735TC, DBO208, DB0235, DB0237,
DB0340, DB0346, DB0347
OEM REF: 028430



SGED91

GRILL ELEMENT - 2100W
DEFY - 620, KITCHENAIRE,
631 GOLD, DSS331, DSS333,
DSS365, DSS378, DSS458
OEM REF: 066400



SGED92

GRILL ELEMENT
DEFY - 621



SGED93

GRILL ELEMENT - 2200W
DEFY - 418, 420,
KITCHENAIRE, GEMINI, 116



SGED94

GRILL ELEMENT - 2800W
DEFY - 422, 425 t/fan,
smooth top, GEMINI

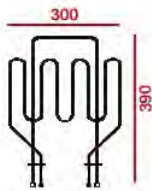

SGED95

GRILL ELEMENT - 2800W
DEFY GEMINI M/F, M/CHEF,
DBO220, DBO221, DBO225,
DBO226
OEM REF: 022414



SGED96

GRILL ELEMENT - 2800W + 300W
DEFY - GEMINI, 550,
gourmet, t/fan

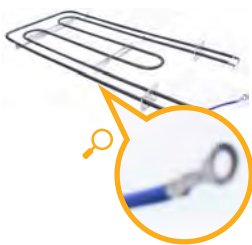

SGED97

GRILL ELEMENT - 2200W + 300W
DEFY - VOGUE, 420, 424



SGED98

GRILL ELEMENT - 2200W + 300W
DEFY - 419 std, 419 solid,
422, 621

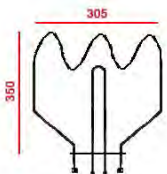

SGEH111

GRILL ELEMENT - 1000W + 3345W
BOSCH OVENS



SGEJ99

GRILL ELEMENT - 1500W
JUNKER RUH - most models

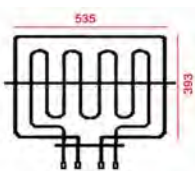

SGEK49

GRILL ELEMENT - 2500W + 1000W
KELVINATOR OVEN -
HCFZ1MAIQD



SGEK52

GRILL ELEMENT - 1250W
KIC STOVE: KP2M2, IGNIS -
GP2M2
OEM REF: 7774Z

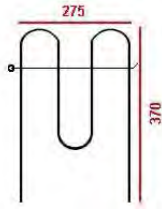

SGEK101

GRILL ELEMENT - 1200W
KIC STOVE - FSB612,
FSB613, FSB623BL, FSP512



SGEK50

GRILL ELEMENT - 2950W
KIC STOVE - FSB400 series



SGEK51

GRILL ELEMENT
KIC STOVE - FSB410, 411



SGEN36

GRILL ELEMENT - 1100W
TELEFUNKEN - TF400



SGEN37

GRILL ELEMENT - 1300W
TELEFUNKEN OVEN - TF400
OEM REF: EAES000002

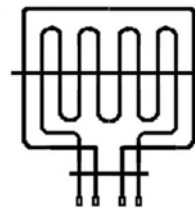

SGES33

GRILL ELEMENT
SAMET stove - NE3F, NE4F



SGES34

GRILL ELEMENT - 2000W + 1100W
SAMET OVENS

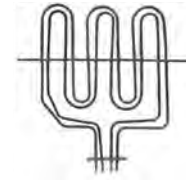

SGES35

GRILL ELEMENT - 3500W
SAMET OVENS

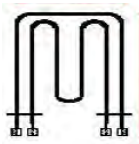

SGEU48

GRILL / BAKE ELEMENT
900/300W
UNIVA - EARLY MODELS



SGEU86

GRILL ELEMENT - 1000W
UNIVA stove - 814E



SGEU87

GRILL ELEMENT - 1800W
UNIVA stove - 204AR, 313,
713, 718, 813, EMERALD &
REGENCY eye-levels



SWEB100

WARMER DRAWER ELEMENT
- 600W
KELVINATOR - all early
models

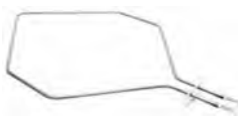

SWEB108

WARMER DRAWER ELEMENT
- 300W
FUCHSWARE - stove - BOU1



SWED101

WARMER DRAWER ELEMENT
- 1300W
DEFY - GEMINI std, cordon
bleu



SWED102
WARMER DRAWER ELEMENT
 - 700W
 DEFY - 425 series
 800 series



SWED103
WARMER DRAWER ELEMENT
 - 475W
 DEFY - 420 (SILVER 70'S),
 424, 422 de Luxe



SWED104
WARMER DRAWER ELEMENT
 - 300W
 DEFY - 419 series (early)



SWED105
WARMER DRAWER ELEMENT
 - 300W
 DEFY - ALLIED



SWED106
WARMER DRAWER ELEMENT
 - 300W
 DEFY - 425 (late)



SWED107
WARMER DRAWER ELEMENT
 - 300W
 DEFY - 116, 316, 416

FUSES: CARTRIDGE, SCREW, HOLDERS



CARTRIDGE FUSES
CERAMIC FUSE 6 x 32mm -
PACK OF 10
 SSF6 - 6 AMP
 SSF10 - 10 AMP
 SSF15 - 15 AMP
 SSF20 - 20 AMP
 SSF25 - 25 AMP



EDISON FUSES
EDISON SCREW STOVE
FUSES
 SEF06 - 6 AMP
 SEF10 - 10 AMP
 SEF15 - 15 AMP
 SEF20 - 20 AMP
 SEF25 - 25 AMP
 SEF30 - 30 AMP



SCUF15
COOKER UNIT FUSE - 15 AMP
 used on mains supply



SDF02
DOUBLE EDISON SCREW
FUSE HOLDER
 DEFY stoves - most models
 pre 1994, also fits various
 other early makes of ovens



SDF03
TRIPLE EDISON SCREW FUSE
HOLDER
 universal application



SFH7
CARTRIDGE FUSE HOLDER
 20 Amp MAX. 32 x 6mm
 cavity - push on terminals



NEON: INDICATORS & PILOT LIGHTS



D62287

PILOT LIGHT
Fits D62289



D62289

CLEAR ROUND LENS
DEFY STOVES D55493



SIM3

NEON PILOT LIGHT - SERIES 70
DEFY stove - various models made between 1987 and 1992



SIM4

NEON PILOT LIGHT - SERIES 67
red - universal application



SIM4A

NEON PILOT LIGHT - SERIES 67
amber - universal application



SIM4G

NEON PILOT LIGHT - SERIES 67
green - universal application



SIR5

NEON PILOT LIGHT - SERIES 65
red - universal application



SIR5A

NEON PILOT LIGHT - SERIES 65
amber - universal application



SIR5G

NEON PILOT LIGHT - SERIES 65
green - universal application



SIW3

NEON PILOT LIGHT
fits KELVINATOR hobs



SIW5

AMBER LENS - SERIES 62 ROUND
suitable with 62 series pilot light



SIW6

RED LENS - SERIES 62 ROUND
suitable with 62 series pilot light



SIW7

NEON PILOT LIGHT - SERIES 62
without lens - universal application



SIW8

AMBER LENS - SERIES 62 SQUARE
suitable with 62 series pilot light



SIW9

RED LENS - SERIES 62 SQUARE
suitable with 62 series pilot light



SW18TAF

NEON INDICATOR LIGHT - 18TAF
amber lens, chrome trim - universal application



SW18TRF

NEON INDICATOR LIGHT - 18TRF
red lens, chrome trim - universal application



SW28AF

NEON INDICATOR LIGHT - 28AF
amber lens, black body - universal application



SW28RF

NEON INDICATOR LIGHT - 28RF, RED LENS BLACK BODY
UNIVERSAL APP

KNOB: CONTROL, CLIPS



4819 411 29274

KNOB, BLACK WHIRLPOOL hob - AKM330



KL-KU60BS201

KNOB - "L" KELVINATOR stove - KU60BS



KL-KU60BS201-B

KNOB, "B" 2 x MIDDLE KELVINATOR stove - KU60BS



KL-KU60BS201-C

KNOB "C" 2 X LEFT KELVINATOR stove - KU60BS



KL-KU60BS201-D

KNOB "D" 1 & 2 RIGHT KELVINATOR stove - KU60BS



SCLP5

KNOB CLIP - 5mm SHAFT
suitable with DEFY knobs



SCLP6

KNOB CLIP - 6mm SHAFT
suitable with DEFY knobs



SNB12475

CONTROL KNOB - 6mm SHAFT
suitable with 80th thermostat black with white script 0-260degC



SNB12476

CONTROL KNOB - 5mm SHAFT

suitable with most energy regulators - 5mm shaft black with white script 0-1-2-3-4-5-6



SNB12478

CONTROL KNOB - 5mm SHAFT

suitable with HA3 three heat switches with original 5mm shaft, black with white script 3-2-1-0



SNB12480

CONTROL KNOB - 6mm SHAFT

suitable with new HA3 three heat switches with 6mm shaft, black with white script 3-2-1-0



SNB12482

CONTROL KNOB - 6mm SHAFT

suitable with 81th thermostat, black with white script 0-260degc + grill



SNB12485

CONTROL KNOB - 6mm SHAFT

suitable with new HA5 five heat switches with 6mm shaft, black with white script 5-4-3-2-1-0



SNB18007

CONTROL KNOB - 6mm SHAFT

DEFY stove - golden 80's series, black with amber indicator line



SNB18009

CONTROL KNOB - 60min RINGER TIMER

DEFY stove - golden 80's series, black with amber indicator line



SNB12477

CONTROL KNOB - 5mm SHAFT

suitable with 70th thermostat black with white script 0-260degC



SNB12479

CONTROL KNOB - 5mm SHAFT

suitable with 71th and 86th thermostats, black with white script 0-260degc + grill



SNB12481

CONTROL KNOB - 6mm SHAFT

suitable with part number SOTH56 (see thermostats), black with white script 0-220degC



SNB12484

CONTROL KNOB - 6mm SHAFT

suitable with most energy regulators - 6mm shaft, black with white script 0-1-2-3-4-5-6



SNB16399

CONTROL KNOB - 5mm SHAFT

DEFY stove - silver 70's series, black with white indicator line



SNB18008

CONTROL KNOB - 5mm SHAFT

DEFY stove - golden 80's series, black with amber indicator line



SNB18010

CONTROL KNOB - 5mm SHAFT

DEFY stove - 422 spiral, 425 spiral, black with amber script 0-1-2-3-4-5-6-7-8



SNB19131

CONTROL KNOB - 6mm SHAFT
DEFY hob - 'off' position at 3 o'clock, black with amber indicator line



SNB19583

CONTROL KNOB - 6mm SHAFT
DEFY stove - 422 glass top, 425 glass top, black with amber script 0-1-2-3-4-5-6-7-8



SNB19934

KNOB LOCK BARREL - 6mm SHAFT
DEFY stove - golden 80's series with glass facia



SNB19938

KNOB BARREL SPRING
DEFY stove - golden 80's series with glass facia



SNB20710

CONTROL KNOB - 60min RINGER TIMER
DEFY hob - 'off' at 3 o'clock position, black with amber indicator line



SNB21779

CONTROL KNOB - 6mm SHAFT
DEFY stove - 422T/F, 425T/F (reversed hole), black with amber indicator line



SNB22318

CONTROL KNOB - 6mm SHAFT
DEFY hob - GEMINI late, black with amber script 0-1-2-3-4-5-6-7-8



SNB19136

CONTROL KNOB - 6mm SHAFT
DEFY stove - 422 solid plate, 425 solid plate, black with amber script 6-5-4-3-2-1-0



SNB19918

CONTROL KNOB - 8mm CAVITY
DEFY stove - golden 80's series with glass facia, black with amber indicator line



SNB19936

KNOB BARREL SEAL - 25mm
DEFY stove - golden 80's series with glass facia



SNB20709

CONTROL KNOB - 6mm SHAFT
DEFY hob - 'off' at 3 o'clock position, black with amber indicator line



SNB21743

CONTROL KNOB - 5mm SHAFT
DEFY stove - 422 spiral, 425 spiral, black with amber indicator line



SNB22316

CONTROL KNOB - 5mm SHAFT + STEM
DEFY stove - GEMINI eye-level late, black with amber script 0-260degC+ grill



SNB22772

CONTROL KNOB - 5mm SHAFT
DEFY stove/hob - golden 80's late, black with amber indicator line



SNB23843

**CONTROL KNOB - 5mm
SHAFT + STEM**
DEFY stove - GEMINI eye-level 'black' series, black with white script 0-1-2-3-4-5-6-7-8



SNB25680

**CONTROL KNOB - 5mm
SHAFT**
DEFY stove/hob - models post 1989, black with red indicator line



SNB25682

**CONTROL KNOB - 5mm
SHAFT**
DEFY hob - GEMINI 'grey' series post 1989, grey with white indicator line



SNB26304

**CONTROL KNOB - 8mm
CAVITY**
DEFY stove - golden 80's series with glass facia, black with white indicator line



SNB29406

**CONTROL KNOB - 6mm
SHAFT**
DEFY stove - SLIMLINE new, black with white script 0-230 + grill



SNB29408

**KNOB, TIMER S/L OVEN BLK
DEFY**



SNB29410

**CONTROL KNOB - 6mm
SHAFT**
DEFY hob - SLIMLINE new, Black with white script 0-1-2-3-4-5-6-7-8



SNB25676

**CONTROL KNOB - 6mm
SHAFT**
DEFY stove/hob - models post 1989, black with red indicator line



SNB25681

**CONTROL KNOB - 5mm
SHAFT**
DEFY hob - GEMINI 'white' series post 1989, white with red indicator line



SNB25685

**CONTROL KNOB - 60min
RINGER TIMER**
DEFY hob - models post 1989, black with red indicator line



SNB29402

**CONTROL KNOB
DEFY SLIMLINE**



SNB29407

**CONTROL KNOB - 60min
RINGER TIMER**
DEFY stove - SLIMLINE new, white with black script



SNB29409

**CONTROL KNOB - 6mm
SHAFT**
DEFY hob - SLIMLINE new, White with black script 8-7-6-5-4-3-2-1-0



SNB29411

**CONTROL KNOB - 6mm
SHAFT**
DEFY stove - SLIMLINE new, White with black script 8-7-6-5-4-3-2-1-0



SNB29414
KNOB, CONTROLE 7 POS.6
HEAT DEF



SNB29417
KNOB, WARMER CONTROL
600 SERIES



SNB420320
CONTROL KNOB - 6mm
SHAFT
KELVINATOR hob - glasstop
models early, black with
white script 0-1-2-3-4-5-6-
7-8-9-10-11-12



SNB524807
CONTROL KNOB - 5mm
SHAFT
suitable for 'ego' thermostat,
black with white script
0-300degC



SNB524813
KNOB, CONTROL CAL 100-
180C 6MM



SNB61788
KNOB, DEFY CONTROL 6mm
BLACK



SNB61990
KNOB, TIMER - HOBS



SNB63696
S/LINE KNOB 0-6 ANTICLOCK
BLK



SNB64815
KNOB, CONTROL 0-5 + 0-5



SNB65364
CONTROL KNOB
6mm
DEFY DHD 340



SNB66080
CONTROL KNOB
DEFY THERMOSTAT KNOB



SNB66087
CONTROL KNOB
DEFY THERMOSTAT KNOB



SNB67014
CONTROL KNOB - 6mm
SHAFT
DEFY stove - NEW SLIMLINE
series, black with white
script 0-230degC + grill



LAMPS: GLOBES, HOLDERS & PARTS



SLAY1

OVEN LAMP HOLDER WITH LENS
DEFY stove - all models with large glass lens



SLAY2

OVEN LAMP HOLDER WITH LENS
DEFY, KELVINATOR, UNIVA stove - all models with small glass lens



SLAY4

OVEN LAMP LENS
suitable with part number: SLAY1



SLAY5

OVEN LAMP LENS GASKET
suitable with part number: SLAY1



SOL2

PYGMY LAMP
25W - SES (E14) - 300degC max



SOL3

UNIVERSAL MINIATURE OVEN GLOBE
15W SES (E14) - 300degC max



SOL5

UNIVERSAL GOLF BALL OVEN GLOBE
40W SES (E14) - 300degC max



SOL6

UNIVERSAL GOLF BALL OVEN GLOBE
40W (E27) - 300degC max



SOL10

CANDLE PEARL LAMP
DEFY cookerhood - 600mm and 900mm models - suitable with most makes of cookerhoods



SOL11

M/WAVE LAMP WITH HOLDER 25W
various brands including LG MODELS - MC-7844, MC-805, MC-9243, MC-9247, MC-924

MISCELLANEOUS



4819 310 39347

**SET OF NOZZLES G30-29/
G31-37**
Gas nozzles for LPG gas



SILICONE

SILICONE SEALANT - 300ml
RSS300B - black
RSS300C - clear
RSS300G - grey
RSS300W - white
RSS310R - heat resistant
(red)

INSULATION TAPE



**HIGH QUALITY NITTO TAPE -
0.13mm x 20m ROLL**
SITBA - blue insulation tape
SITB2A - black insulation
tape SITGA - green
insulation tape SITRA - red
insulation tape SITWA -
white insulation tape SITYA
- yellow insulation tape

Available Colors: 

PANS: BAKE TRAYS, BROILERS, SHELVES



D663054

NEW RACK TYPE BROILER
fits standard roast pans



D663366

ROAST PAN
FITS ALL STOVES



SBKTRAY

UNIVERSAL ENAMEL BAKE TRAY
440 X 380



SHELVES

D655748 - 440 x 380 SLIMLINE
OVENS
D667908 - 397 x 375 500
SERIES
D667910 - 476 x 678 600
SERIES
D668059 - DEFY GEMINI SERIES



SSH1

**UNIVERSAL OVEN SHELF
EXTENDABLE**
400mm x 300mm



PLATES, CUPS & RINGS



S300

6" SPIRAL PLATE
PINEWARE hotplate - all spiral models - and varies two plate stoves



S600C

6" (150mm) 4 TURN SPIRAL PLATE - 1350W
DEFY hob/stove - all spiral models



S600E

6" 3 TURN SPIRAL PLATE
DEFY 520 COMPACT
OEM REF: 061368



S800C

8" (200mm) 5 TURN SPIRAL PLATE - 2000W
DEFY hob/stove - all spiral models



S800E

8" 4 TURN SPIRAL PLATE
DEFY 520 COMPACT
OEM REF: 061369



SCUP4

6" (150mm) SHALLOW REFLECTOR CUP
DEFY hob/stove - all spiral hobs late



SCUP5

8" (200mm) SHALLOW REFLECTOR CUP
DEFY hob/stove - all spiral hobs late



SCUP6

6" (150mm) DEEP UNDERCUP
DEFY hob/stove - all spiral hobs early



SCUP8

SERIES 8" (200mm) DEEP UNDERCUP
DEFY hob/stove - all spiral hobs early



SP29

SOLID PLATE 145MM
NU-TEC mini oven NCO-022



SP30

SOLID PLATE 180MM
NU-TEC mini oven NCO-022



SP59U

SOLID PLATE 145mm - 1000W
22mm chrome trim ring - universal application
EGO REF: 12.14453.194SP



SP61U

SOLID PLATE 180mm - 1500W
22mm chrome trim ring - universal application



SP63U

SOLID PLATE 220mm - 2000W
22mm chrome trim ring - universal application



SP68RP

145mm SHALLOW RADIANT PLATE - 1200W
DEFY hob/stove - all glasstop hobs excluding models made before 1979; KELVINATOR hob/stove - all glasstop hobs



SP69RP

210mm SHALLOW RADIANT PLATE - 2100W
DEFY hob/stove - all glasstop hobs excluding models made before 1979; KELVINATOR hob/ stove - all glasstop hobs



STR01

6" (150mm) CHROME TRIM RING
DEFY hob/stove - all spiral hobs



STR02

8" (200mm) CHROME TRIM RING
DEFY hob/stove - all spiral hobs



STR03

145mm CHROME TRIM RING
DEFY STOVE - 520 SERIES



STR04

180mm CHROME TRIM RING
DEFY STOVE - 520 SERIES



SOLID PLATE MATRIX

PART NUMBER	DIAMETER	TRIM	WATTAGE	RED DOT	TRIM COLOUR
SP35A	145mm	8mm	1000W		CHROME
SP36BA	145mm	8mm	1000W		BLACK
SP37A	145mm	4mm	1000W		CHROME
SP38BA	145mm	4mm	1000W		BLACK
SP39HSA	145mm	8mm	1500W	YES	CHROME
SP40HSB	145mm	8mm	1500W	YES	BLACK
SP41HSA	145mm	4mm	1500W	YES	CHROME
SP42HSBA	145mm	4mm	1500W	YES	BLACK
SP46A	180mm	8mm	1500W		CHROME
SP47BA	180mm	8mm	1500W		BLACK
SP48A	180mm	4mm	1500W		CHROME
SP49BA	180mm	4mm	1500W		BLACK
SP51HSA	180mm	8mm	2000W	YES	CHROME
SP52HSB	180mm	8mm	2000W	YES	BLACK
SP53HSA	180mm	4mm	2000W	YES	CHROME
SP54HSBA	180mm	4mm	2000W	YES	BLACK
SP57	220mm	8mm	2000W		CHROME
SP59U	145mm	22mm	1000W		CHROME
SP61U	180mm	22mm	1500W		CHROME
SP63U	220mm	22mm	2000W		CHROME

SP35A PREVIEW



ROTISSERIES: MOTORS, SPITS & HANDLES

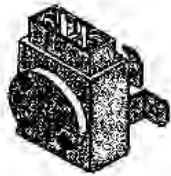

SRM

ROTISSERIE REDUCING MOTOR
DEFY stove - all rotisserie models pre 1992



SRSH

ROTISSERIE SPIT HANDLE
DEFY stove - all rotisserie models pre 1992

SEALS: HOB FRAME GLASS

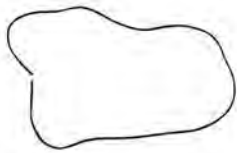

D24968

SEAL STRIP - BLACK



SHS1

UNIVERSAL HOB GASKET - 2 metre BLACK
suitable with all built in hobs



SHS2

SEAL STRIP
DEFY HOBS

SWITCHES



4819 273 28445

DOUBLE ROTARY SWITCH
WHIRLPOOL hob - KH701
ORIGINAL PART



D163925001

DEFY SWITCH
DHD314 / DHD315



D163925006

DEFY SELCTOR SWITCH - 215P
DHD318 DOMINO SPC
CERAN HOB



D19945

TANDEM ROTARY SELECTOR SWITCH
DEFY stove - all thermofan dual models used with EGO 'T' thermostat
ORIGINAL PART



D25519

SELECTOR SWITCH
DEFY MULTICHEF

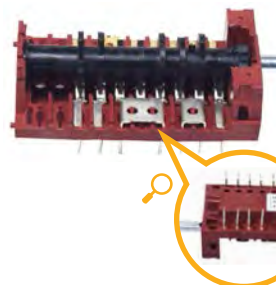

KL-33301003

5 POSITION (4 + OFF) OVEN SELECTOR SWITCH
KELVINATOR KC600BS / KC60055



SER1

SATCHWELL ENERGY REGULATOR
16AMP max. - 5mm shaft
bush mount
type: NF-1



SER2

SATCHWELL ENERGY REGULATOR
16AMP max. - 5mm shaft
screwmount
type: NF-1



SER2B

SATCHWELL ENERGY REGULATOR
16AMP max. - 6mm shaft
screw mount
type: NF-1



SER3

EGO ENERGY REGULATOR
16AMP max. - 6mm shaft
screw mount (converts to bush mount for DEFY application)
type: EGO 50.57021.010



SER3A

EGO ENERGY REGULATOR - ANTI CLOCKWISE ROTATION
16AMP max. - 6mm shaft
screw mount
type: EGO 50.57020.010



SER3C

ENERGY REGULATOR UNITHERM



SER6A

SUNVIC TYPE ENERGY REGULATOR
16AMP max.- 5mm shaft
bush mount



SER8A

DIAMOND 'H' ENERGY REGULATOR
16AMP max. - 5mm shaft
bush mount
type: 41ER



SER12

SIEBEL ENERGY REGULATOR
16AMP max. - 6mm shaft
screw mount



SER13

SIEBEL ENERGY REGULATOR
16AMP max. - 6mm shaft
bush mount



SER14

REGULATOR, ENERGY
16AMP max. - 5mm shaft
bush mount



SERKIT

CENTRE BUSH MOUNT KIT
to convert screw mount switches to bush mount



SW102
4 POSITION SELECTOR SWITCH
 suitable for KELVINATOR stoves



SW227
SWITCH, SELECTOR **7 POS**
 KELVINATOR stove - KU60BS / KC9650



SW228
SWITCH, SELECTOR **5 POS**
 KELVINATOR stove - KU60BS



SW301
SELECTOR SWITCH
 suitable for KELVINATOR stoves



SW302
SELECTOR SWITCH
 suitable for KELVINATOR stoves



SW308
SELECTOR SWITCH
 UNIVA B/1 oven



SW310
SELECTOR SWITCH
 UNIVA stove



SW500
7 POSITION ROTARY SWITCH
 6 heat + off, suitable with DEFY, KELVINATOR, KIC and other solid plate hobs
 type: EGO 46.27266.500



SW500C
SWITCH, 7POS (6H+OFF)
 UNITHERM
 universal application



SW510
TANDEM SELECTOR SWITCH
 KIC undercounter ovens - all 'UCC' models



SW511
4 POSITION SWITCH
 suitable for KELVINATOR stoves
 EGO REF: 42.04400.011



SW515

5 POSITION SWITCH
UNIVA stove / SAMET ovens



SW520

4 POSITION ROTARY SWITCH
3 heat + off, suitable with DEFY, KIC and other solid plate hobs
type: EGO 46.24866.520



SW520C

SWITCH, 4 POS 3HT + OFF UNITHM
universal application



SW530

4 POSITION ROTARY SWITCH
3 position + off (pre-heat, bake, grill) suitable with UNIVA
type: EGO 46.24966.530



SW533

SWITCH - 7 POSITION
KIC hobs - HOB912, HOB913; WHIRLPOOL - AKB526, AKB527, AKB530, AKB531; also fits SAMET, AEG, & JUNKER RUH
OEM REF: 050033



SW718

7 POSITION ROTARY SWITCH
fits KELVINATOR, SAMET & WHIRLPOOL ovens



SW965

SELECTOR SWITCH
KELVINATOR OVENS
KC9650



SW1007

2 POSITION ROTARY SWITCH
DEFY stoves / KELVINATOR

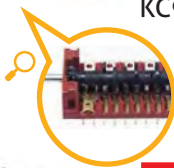

SWHA3

4 POSITION ROTARY SWITCH - HA3/13
3 heat + off - 6mm shaft push-on terminals



SWHA3-10

4 POSITION ROTARY SWITCH - HA3P
3 heat + off + pilot - 6mm shaft screw terminals



SWHA3P

4 POSITION ROTARY SWITCH - HA3/10
3 heat + off - 6mm shaft push-on terminals



SWHA5

6 POSITION ROTARY SWITCH - HA5P
5 heat + off + pilot - 6mm shaft screw terminals



SWT70SMD
PORCELAIN TOGGLE SWITCH
 - 70 SMD
 metal dolly - screw
 terminals



SWT70TMD
PORCELAIN TOGGLE SWITCH
 - 70 TMD
 metal dolly - push-on
 terminals



SWTOG
BAKELITE SWITCH
 metal dolly - screw
 terminals



SWTOG2
ON/ON SWITCH - BEZEL
METAL DOLLY - SCREW
TERMINALS

ROCKER SWITCH MATRIX

PART NUMBER	TYPE	LENS	BODY	TRIM	LIGHT
SW14WF	14 WF - CENTRE OFF	WHITE	WHITE	NO TRIM	
SW15AF	15 AF - ON/OFF	AMBER	WHITE	NO TRIM	ILLUMINATED
SW15BF	15 AF - ON/OFF	BLACK	WHITE	NO TRIM	
SW15RF	15 TRF - ON/OFF	RED	WHITE	NO TRIM	
SW15TAF	15 TAF - ON/OFF	AMBER	WHITE	CHROME	
SW15TBF	15 TBF - ON/OFF	BLACK	WHITE	CHROME	
SW15TRF	15 TRF - ON/OFF	RED	WHITE	CHROME	
SW15TWF	15 TWF - ON/OFF	WHITE	WHITE	CHROME	
SW15WF	15 WF - ON/OFF	WHITE	WHITE	NO TRIM	
SW16AF	16 AF - CHANGE OVER	AMBER	WHITE	NO TRIM	



PART NUMBER	TYPE	LENS	BODY	TRIM	LIGHT
SW16COB	MINI CHANGE OVER	BLACK	BLACK	NO TRIM	
SW16COW	MINI CHANGE OVER	WHITE	WHITE	NO TRIM	
SW16RF	16 RF - CHANGE OVER	RED	WHITE	NO TRIM	
SW16TAF	16 TAF - CHANGE OVER	BLACK	WHITE	CHROME	
SW16TBF	16 TBF - CHANGE OVER	AMBER	BLACK	CHROME	
SW16TRF	16 TRF - CHANGE OVER	RED	WHITE	CHROME	
SW16TWF	16 TWF - CHANGE OVER	WHITE	WHITE	CHROME	
SW16WF	16 WF - CHANGE OVER	RED	WHITE	NO TRIM	
SW17AF	17 AF - ON/OFF	AMBER	WHITE	NO TRIM	ILLUMINATED
SW17RF	17RF ON/OFF	RED	WHITE	CHROME	ILLUMINATED
SW17TAF	17 TAF - ON/OFF	AMBER	WHITE	CHROME	ILLUMINATED
SW17TRF	17 TRF - ON/OFF	RED	WHITE	CHROME	ILLUMINATED
SW25AF	25 AF - ON/OFF	AMBER	BLACK	NO TRIM	
SW25BF	25 BF - ON/OFF	BLACK	BLACK	NO TRIM	
SW25WF	25 WF - ON/OFF	WHITE	BLACK	NO TRIM	
SW26AF	26 AF - CHANGE OVER	AMBER	BLACK	NO TRIM	
SW26BF	26 BF - CHANGE OVER	BLACK	BLACK	NO TRIM	
SW26RF	26 RF - CHANGE OVER	RED	BLACK	NO TRIM	
SW27AF	27 AF - ON/OFF	AMBER	BLACK	NO TRIM	ILLUMINATED
SW27RF	27 RF - ON/OFF	RED	BLACK	NO TRIM	ILLUMINATED

TERMINALS: BLOCKS, COVERS & LUGS



4819 290 68401
PLATE CONNECTOR BLOCK
 WHIRLPOOL oven - AKM330
 ORIGINAL PART



D63359
MINS TERMINAL BLOCK
 DEFY stoves and hobs



KPC15
SINGLE PORCELAIN CONNECTOR
 5AMP max.

KPC26
DOUBLE PORCELAIN CONNECTOR
 6AMP max.

KPC35
TRIPLE PORCELAIN CONNECTOR
 5AMP max.

KPC115
SINGLE PORCELAIN CONNECTOR
 15AMP max.

KPC215
DOUBLE PORCELAIN CONNECTOR
 15AMP max.

KPC315
DOUBLE PORCELAIN CONNECTOR
 15AMP max.



PBC
DUAL PUSH-ON TERMINAL - BRASS
 6.3mm - pack of 100



POC1
PUSH-ON TERMINAL - NICKEL/SILVER
 6.3mm - pack of 25



PRC1
RING TERMINAL - BRASS
 4mm - pack of 25

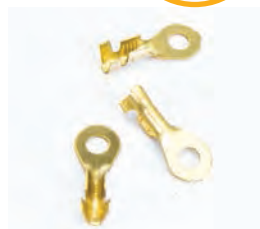

PRC51
RING TERMINAL - BRASS
 5mm - pack of 25



▾ PSE1

**SIDE ENTRY PUSH-ON
TERMINAL - BRASS**
6.3mm - pack of 25



▾ SMTB2

**UNIVERSAL MAINS
TERMINAL BLOCK**
3 x live, 2 x neutral points
suitable with DEFY and
other makes of stoves



▾ STB06

STRIP CONNECTOR
6AMP max. - 250V



▾ STB15

STRIP CONNECTOR
15AMP max. - 250V



▾ STB02A

**SPIRAL PLATE TERMINAL
BLOCK**
DEFY stove - all single coil
spiral plate models



▾ STB04

**SOLID PLATE TERMINAL
BLOCK**
Fits most solid plates with 4
terminals

▾ THERMOFANS: MOTORS & BLADES



▾ SCOM3

**THERMOFAN MOTOR
ASSEMBLY**
DEFY stove - all thermofan
models



▾ SCOM3FAN

FAN BLADE
suitable with part number:
SCOM3



▾ SCOM4

**TANGENTIAL FAN MOTOR
ASSEMBLY**
fits various ovens including
KIC, DEFY & SAMET



▾ SCOM5

GASKET, HEAT RESISTANT
SUITABLE WITH PART
NUMBER : SCOM3

THERMOSTATS & THERMOMETERS



460

OVEN THERMOMETER
0-300°C
UNIVERSAL APPLICATION



D65884

THERMOSTAT GTLH-BUSH MNT
DEFY ovens - SLIMLINE
600S, 621, 51, compact
gold, 521 metallic



D65885

THERMOSTAT - SCREW MNT
DEFY ovens - 600C,
DBO331/371/376,
DSS436/437/438/440



DY30

THERMOFAN THERMAL CUTOUT
DEFY thermofan; also fits
INDESIT model - CIE and
SUPREME/REGAL stoves,
most DEFY stoves
ORIGINAL PART



SOTH01

UNIVERSAL THERMOSTAT KIT
suitable to replace: 3TH,
9TH, 51TH, 56TH, 70TH,
71YH, 80TH, 81TH, 86TH;
kit includes thermostat,
diagrams, fitting
instructions, knob and bush
mount kit



SOTH02

86TH THERMOSTAT - 5mm SHAFT BUSH MOUNT
DEFY stove - SILVER 70'S:
118, 418, 420, 424, 500
eye-level, ALLIED, CADETTE,
HOSTESS, MAJORETTE,
SPACESAVER, SUPER
TWENTY, VOGUE; UNIVA
stove - all early models -
replaces 51th



SOTH03

80TH THERMOSTAT - 6mm SHAFT SCREW MOUNT
KELVINATOR stove - B4700,
B5700, eye-level oven



SOTH04

71TH THERMOSTAT - 6mm SHAFT SCREW MOUNT
DEFY stove - all standard
models post 1997;
KELVINATOR stove - S1620,
S2620, S2640, S2840,
S3840



SOTH05

71TH THERMOSTAT - 6mm SHAFT BUSH MOUNT
UNIVA stove - 182B



SOTH06

71TH THERMOSTAT - 6mm SHAFT BUSH MOUNT
DEFY stove - all standard
models post 1995



SOTH07

**70TH THERMOSTAT - 6mm
SHAFT SCREW MOUNT**
KELVINATOR stove - S2650,
S2651



SOTH08

**70TH THERMOSTAT - 5mm
SHAFT BUSH MOUNT**
(780mm CAP)
DEFY stove - golden 80's
series - all freestanding
models 1979 thru 1987
excluding thermofan ovens



SOTH09

**70TH THERMOSTAT - 5mm
SHAFT BUSH MOUNT**
(1850mmCAP)
DEFY stove - GEMINI
standard eye-level pre 1987



SOTH10

**71TH THERMOSTAT - 5mm
SHAFT BUSH MOUNT**
DEFY stove - all models post
1987 excluding thermofan
models



SOTH11

**72TH THERMOSTAT - 5mm
SHAFT BUSH MOUNT**
DEFY stove - 422 T/F dual,
425 T/F dual, 765 T/F dual,
GEMINI T/F dual eye-level



SOTH13

**81TH THERMOSTAT - 6mm
SHAFT BUSH MOUNT**
DEFY stove - SLIMLINE 600
series early



SOTH14

**81TH THERMOSTAT - 6mm
SHAFT SCREW MOUNT**
DEFY stove - SLIMLINE 600
series late, 831; KELVINATOR
stove - B4610, B4710,
B5610, B5620, B6610,
B6620 eye-level



SOTH15

**TV2/3 THERMOSTAT
REPLACEMENT KIT**
FUCHSWARE stove - all
early models, includes
thermostat, diagram, knob,
pilot lights, and fitting
instructions



SOTH51

**'T150' THERMOSTAT - 6mm
SHAFT SCREW/BUSH MOUNT**
DEFY stove - 119, 319, 419,
511, all thermofan models;
UNIVA stove - late models
with separate grill control
0-300 degC



SOTH51A

THERMOSTAT UNITHERM
50-300degC
universal application

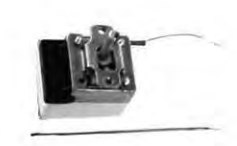

SOTH51L

**'T150' THERMOSTAT - 6mm
SHAFT SCREW/BUSH MOUNT**
similar to part number
SOTH51, but with 1,8 metre
capillary

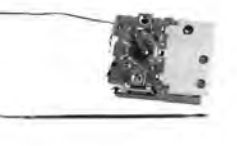

SOTH51S

**'T150' THERMOSTAT - 6mm
SHAFT SCREW/BUSH MOUNT**
EGO thermostat 0-320degC
1,2metre s/ steel capillary



▼ SOTH51U

**THERMOSTAT 50-300degC +
KNB & BEZEL**
universal application



▼ SOTH69

**THERMOSTAT 0-250degC
KELVINATOR**
KC680 / DEFY GEMINI
55.17044.010

▼ TIMERS & CONTROL UNITS



▼ D23715

**TIMER, RINGER 60min +
LOCK NUT**
DEFY ovens - SLIMLINE 600S
series



▼ D24569

DIEHL TIMER - RED
DEFY GEMINI multifunction,
DEFY stove 735TC

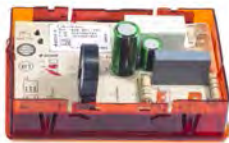

▼ D68117

**TIMER, - BARACUDA 6
BUTTON**
DEFY DB0 series

▼ WIRE



▼ SILICONE WIRE

**SILICONE WIRE - 2,5mm PER
METRE**
SSW01A - brown silicone
wire
SSW02A - blue silicone wire
SSW03A - green silicone
wire
SSW04A - black silicone
wire
SSW05A - red silicone wire



▼ SILICONE WIRE

**SILICONE WIRE - 1,5mm PER
METRE**
SSW11 - brown silicone wire
SSW12 - black silicone wire
SSW13 - green silicone wire
SSW14 - blue silicone wire
SSW15 - red silicone wire



04



REFRIGERATION



BASKETS / COVERS



D13299

**CHEST FREEZER BASKET
(PLASTIC)**
D1623020



D1523020.0

**FRONT BASKET COVER
(CLEAR)**
DEFY DFC 368 / 346
433 X 180



D1523017

**FRONT BASKET COVER
TONEYMIST DEFY**
DS640 / F04C / DFF222,
392/404



D17266

**FRONT BASKET COVER
(CLEAR)**
DAC 452, 453, 456



RDFB

**CHEST FREEZER BASKET
(WIRE)**
UNIVERSAL APPLICATION

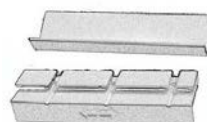

RDFH

**FREEZER BASKET HANDLE
FITS RDFB FREEZER BASKET**

CAPACITORS

CAP25

CAPACITOR, 25 MFD 450V

CAP35

CAPACITOR, 35 MFD 450V

CAP40

CAPACITOR, 40 MFD 450V

CAP45

CAPACITOR, 45MFD 450V

CAP50

CAPACITOR 53-64 MFD 250V

CAP60

CAPACITOR, 60 MFD 450V

CAP30

CAPACITOR, 30 MFD 450V

CAP36/43

CAPACITOR, START 36/43MFD 250V

CAP43/52

CAPACITOR, START 43/52MFD 250V

CAP47/56

CAPACITOR, START 47/56MFD 250V

CAP50-450

CAPACITOR 50MFD 450V

CAP64/77

CAPACITOR, START 64/77MFD 250V

CAP70

CAPACITOR, 70 MFD 450V

CAP108/130

CAPACITOR, START 108/130MFD 250V

CAP145/174

CAPACITOR, START 145/174MFD 250V

CAP189/227

CAPACITOR, START 189/227MFD 250V

CAP88/106

CAPACITOR, START 88/106MFD 250V

CAP130/156

CAPACITOR, START 130/156MFD 250V

CAP161/193

CAPACITOR, START 161/193MFD 250V

CAP216/259

CAPACITOR, START 216/259MFD 250V

COMPRESSOR SIZE GUIDE

UNIT CAPACITY (LITRES)	UNIT TYPE	SUGGESTED COMPRESSOR SIZE
100-160	SINGLE DOOR	1/12HP AIR COOLED
170-200	SINGLE DOOR	1/10HP AIR COOLED
210-255	SINGLE DOOR	1/8HP AIR COOLED
260-350	SINGLE DOOR	1/6HP AIR COOLED
355-420	SINGLE DOOR	1/5HP OIL COOLED
220-340	DOUBLE-DOOR	1/5HP OIL COOLED
350-485	DOUBLE-DOOR	1/4HP OIL COOLED
490-600	DOUBLE-DOOR	1/3HP OIL COOLED
110-180	FREEZER	1/6HP AIR COOLED
190-225	FREEZER	1/5HP OIL COOLED
230-370	FREEZER	1/4HP OIL COOLED
380-510	FREEZER	1/3HP OIL COOLED
520-620	FREEZER	3/8HP OIL COOLED



ONE DOOR UNDERCOUNTER UNIT

1/4HP

TWO DOOR UNDERCOUNTER UNIT

1/3HP

THREE DOOR UNDERCOUNTER UNIT

3/8HP

FOUR DOOR UNDERCOUNTER UNIT

1/2HP

FIVE DOOR UNDERCOUNTER UNIT

3/4HP

SIX DOOR UNDERCOUNTER UNIT

1HP

ONE DOOR BEVERAGE COOLER

3/8HP

TWO DOOR BEVERAGE COOLER

1/2HP

THREE DOOR BEVERAGE COOLER

3/4HP

DOMESTIC COMPRESSORS



BRANDS: SIBIRIA & EMBRACO
SIZES (HP): 1/3, 1/4, 1/5, 1/6,
1/8, 1/10, 1/12
REFRIGERANT: R134a

ROTARY COMPRESSORS



BRANDS: LG, UNITHERM
SIZES (BTU) : 9000 TO
30000
REFRIGERANT: R22

RANGE OF R600 DOMESTIC ALSO AVAILABLE

CONTROL UNITS



4812 218 48126

P.C.B ASSEMBLY - WHITE
WHIRLPOOL - WRF40



4812 218 78007

P.C.B ASSEMBLY - BLACK
WHIRLPOOL - WRF40



D1000001

P.C.B ASSEMBLY
DEFY NEW TYPE
SPIN, RF640, FF04



D1000005

SENSOR EVAPORATOR
COIL 3 PIN
DEFY - DFF366



D1000006

SENSOR - CABINET 2 PIN
DEFY REFRIGERATORS -
F640, DFF366, F350



D1000009

P.C.B ASSEMBLY
DEFY W/O COVER
5PIN DFF366, F640, DFF336,
F350, DUF256



D1000026

FAN SENSOR
DEFY FRIDGE



D1000047

SENSOR EVAPORATOR
DEFY FRIDGE

COPPER TUBING

2216901054

COPPER, TUBING 3/16" 15M COIL

2216902054

COPPER, TUBING 5/16" 15m COIL

2216901554

COPPER TBG.1/4" 15M 0.61MM WL

221690255

COPPER TBG.3/8" 15M 0.61MM WL

2216903054

COPPER TBG.1/2" 15M 0.71MM WL

2216903554

COPPER TUBING 5/8" 15M COIL

2216904054

COPPER TUBING 3/4" 15M COIL

2216905054

COPPER S/D 1/4 R410 COMPATIBLE

2216906554

COPPER S/D 3/8 R410 COMPATIBLE

2216906054

COPPER S/D 1/2 R410 COMPATIBLE

2216905554

COPPER S/D 5/8 R410 COMPATIBLE

2216907054

COPPER S/D 3/4 R410 COMPATIBLE



SPECIAL GASKETS

Tecsca also manufacture Fridge/Freezer gaskets to customers requirements. Profile "A" & "C" are available in grey or white and profile "B" in white only. A reasonable period of time is required to manufacture these gaskets. In addition gaskets with the following profiles can be ordered according to customers requirements but a longer lead time is required as these are outsourced. Certain profiles are also available in black.

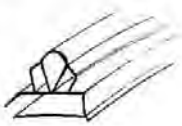

PROFILE SP001-WHITE

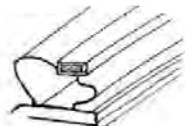

PROFILE SP006-WHITE



PROFILE SP020-WHITE



PROFILE SP002-WHITE

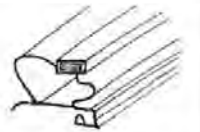

PROFILE SP007-WHITE



PROFILE SP010-GREY

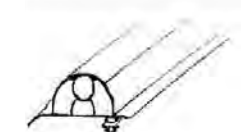

PROFILE SP030-WHITE

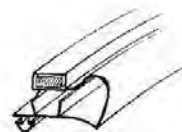

PROFILE SP004-WHITE



PROFILE SP009-BROWN



PROFILE SP013-BLACK



PROFILE SP040-WHITE

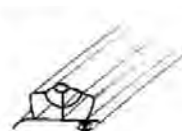

PROFILE SP005-BLACK



PROFILE SP018-WHITE

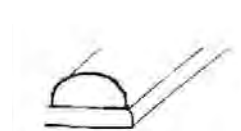

PROFILE 'D' -WHITE

Original seals are also available for the following:
BAUER / PALFRIDGE, L.G, SAMSUNG, TELEFUNKEN, DEFY, KIC, WHIRLPOOL, IGNIS

Certain profiles are also available in black.

DOOR HANDLES



4801 311 00468

HANDLE ASSEMBLY
WHIRLPOOL WM1854 A + X
HANDLE GREY



4810 104 66993

HANDLE COVER
WHIRLPOOL



D14198

INSERT, HANDLE DEFY
DEFY chest freezers - late models



D14212

HANDLE, CHEST FREEZER
DEFY
HANDLE, CHEST FREEZER
DEFY



FM-120060

HANDLE ASSEMBLY
FRIDGEMASTER refrigerators
- BF315/330/355/370,



FM-120085

HANDLE ASSEMBLY
FRIDGEMASTER refrigerators
- BF415, BF450, BF455,
BF500, BF535, SS475,
SS500, SS640, SS650,
TF420, TF490
ORIGINAL PART

DOOR LATCHES, HINGES, BUSHES



4318165

DOOR CAM - KIT
Various WHIRLPOOL
refrigerators
ORIGINAL PART



4619 560 00950

BOTTOM HINGE ASSEMBLY
KIC/WHIRLPOOL double door
refrigerators - late models



4619 560 24160

HINGE - PART A
KIC chest freezer - KC0015



4619 560 24170

HINGE - PART B
KIC chest freezer - KC0015



4812 908 00488

CENTRE HINGE
All KIC/WHIRLPOOL locally
manufactured double door
refrigerators



4812 908 00599

LOCK ASSEMBLY
KIC refrigerators - double
door



D17453

**NYLON CHEAT
FREEZER HINGE**
Suitable with smaller chest
freezers, i.e. OCEAN etc.



D5525045

CENTRE HINGE
DEFY REFRIGERATORS -



RDCH

CHEST FREEZER HINGE
Spring loaded - suitable
with DEFY, KIC, and various
other makes of chest
freezers



RDHB2

HINGE BUSH
6mm I.D., 10mm O.D.



RDST1

DOOR STOPPER
Fits KIC/WHIRLPOOL
refrigerators



TF-20010038

CENTRE HINGE
TELEFUNKEN REFRIGERATOR
- TDC-240S



TF-20020251

UPPER HINGE
TELEFUNKEN REFRIGERATOR
- TSF260S



TF-20021249

CENTRE HINGE
TELEFUNKEN REFRIGERATOR
- TDD210S



TF-20021371

LOWER HINGE
TELEFUNKEN REFRIGERATOR
- TRS-330

DOOR LOCKS AND KEYS



4812 908 0001

KEY
KIC refrigerators - most models



4812 908 00001

UNIVERSAL KEY (FRIDGE/FREEZER)
Universal key (fridge/freezer)



4812 908 00599

LOCK ASSEMBLY
KIC refrigerators - 'WBF' and 'KB' series



D13875

KEY, CHEST FREEZER HANDLE
DEFY chest freezers - DMF291/2/3/4, DMF344/5/7, DMF420/1/2/3/4/5



FM-110240

LOCK ASSEMBLY FRIDGEMASTER frost-free refrigerators - SR340, SR460, SR510

DRYERS

1204002020

COMM.DRIER 1/4 THREADED

1204003020

COMM.DRIER 1/2 THREADED

1204003520

COMM.DRIER 3/8" 180MM THREADED

1204005020

COMM.DRIER 1/2" 169MM THREADED

1204008520

COMM.DRIER 1/4" SWEAT-ON 160MM

1204009020

COMM.DRIER 3/8" SWEAT-ON 154MM

1204009520

COMM.DRIER 3/8 SWEAT ON 153

1204010020

COMM.DRIER 3/8" SWEAT-ON 174MM

1204011020

COMM.DRIER 1/2 SWEAT ON

1204011520

COMM.DRIER 1/2 SWEAT ON

1204012520

COMM.DRIER 5/8 SWEAT ON

1204010520

COMM.DRIER 3/8 SWEAT ON



1204006020

COMM.DRIER 5/8" FLARE 195mm LNG

1204004020

COMM.DRIER 3/8" THREADED

1204005520

COMM,DRIER 1/2 THREADED

1204006520

COMM,DRIER 5/8 THREADED

1204001520

COMM.DRIER 1/4" 144MM THREADED

1204003020

COMM.DRIER 3/8" 145mm THREADED

1204013020

COMM.DRIER 1/2 SWEAT ON

1204013020

COMM.DRIER 5/8 SWEAT ON

1204000520

COMM.DRIER 1/4" 102MM THREADED

1204001020

COMM.DRIER 1/4" 118MM THREADED

1204007520

COMM.DRIER 1/4" SWEAT-ON 102MM

1204002520

COMM.DRIER 3/8" 128MM THREADED



1203701020

15 GRAM PENCIL DRIER
Single entry



1203702020

25 GRAM PENCIL DRIER
Single entry



1203702520

30 GRAM PENCIL DRIER
Single entry - compatible
with all refrigerants



1203704520

DRIER PENCIL 10G
Double entry

EVAPORATOR PLATES



REP01

EVAPORATOR PLATE - 260 X 370MM
Single entry



REP02

EVAPORATOR PLATE - 300 X 633MM
Double entry



REP04

EVAPORATOR PLATE - 360 X 205MM
Double entry



REP05

EVAPORATOR PLATE - 232 X 430MM
Double entry



REP06

EVAPORATOR PLATE - 400 X 240MM
Double entry



REP13

EVAPORATOR PLATE - 300 X 460MM
Double entry includes defrost element



REP14

EVAPORATOR PLATE - 251 X 430MM
Double entry



REP15

EVAPORATOR PLATE - 400 X 500MM
Double entry



REP16

EVAPORATOR PLATE - 300 X 1350MM
Double entry



REP18

EVAPORATOR PLATE - 305 X 990MM
Double entry



REP19

EVAPORATOR PLATE - 264 x 380mm
DOUBLE ENTRY



FEET



RLF8

LEVELLING FOOT - 8MM
Suitable with many fridges
and freezers



RLF10

LEVELLING FOOT - 10MM
Suitable with many fridges
and freezers

GAS REGULATORS, CONVERSION KITS



RGCK

**PARAFFIN TO GAS
CONVERSION KIT**
Includes IGNITOR



RGCK-S

**GAS CONVERSION KIT -
SMALL RING**
Universal application

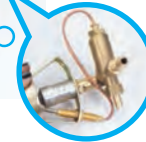

RGR1

UNIVERSAL GAS REGULATOR
1/2" connectors



HEATER MATS



RHP003

**DRAIN THROUGH HEATER
MAT - 16 WATT**
Universal application



RHP004

**TUBE HEATER MAT -
10 WATT**
Universal application

HEATING ELEMENTS

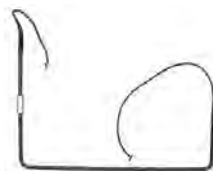

LG-5300JB1050B

HEATER-SHEATH GR369
LG refrigerator - GR-369,
GR-389, GR-409



RDE1

DEFROST ELEMENT
KIC FRIDGES - MOST
DOUBLE DOOR MODELS,
CAN BE BENT TO SHAPE
ORIGINAL PART



RDE2
200W DEFROST ELEMENT CC LONG



RDE3
200W DEFROST ELEMENT CC SHORT



RDE4
DEFROST ELEMENT 350W DEFY REFRIGERATION - DUF 230/8



RDE6
DEFROST ELEMENT - 320W DEFY REFRIGERATOR - F640



RFHE2
CARAVAN FRIDGE/FREEZER ELEMENT - 12V/220V 115W - 17mm O.D. 121mm long



RFHE3
BARLOWS CERAMIC ELEMENT - 220V 400W - 29,6mm O.D. 170mm LONG



RFHE4
OZEN FREEZER ELEMENT - 220V 350W - 25mm O.D., 185mm long with mounting piece



RFHE4-WL
350W OCEAN ELEMENT C/W LEADS



RFHE5
OCEAN 'L' SHAPE ELEMENT - 220V 260W - 9,5mm O.D. 190mm long (total)



RFHE7
OCEAN 'L' SHAPE ELEMENT - 220V 220W - 9,5mm O.D. 190mm long (total)



RFHE8
ELECTROLUX FREEZER ELEMENT - 220V 220W - 21,4mm O.D. 195mm LONG



RFHE9
CARAVAN FRIDGE/FREEZER ELEMENT - 12V/220V 130W - 17mm O.D. 121mm long



RFHE10

ZERO FREEZER ELEMENT - 220V
Single entry - compatible with all refrigerants

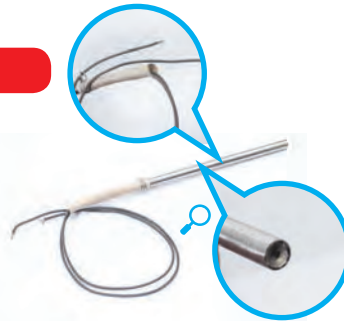

RFHE11

FRIDGE STEEL ELEMENT - 220V
125W - 9,5mm O.D.
125mm long



RFHE12

ZERO 280 LT UPRIGHT FREEZER ELEMENT - 220V
280W - 17mm O.D.
230mm long



RFHE13

CARAVAN FRIDGE/FREEZER ELEMENT - 220V ONLY
160W - 17mm O.D.
121mm long

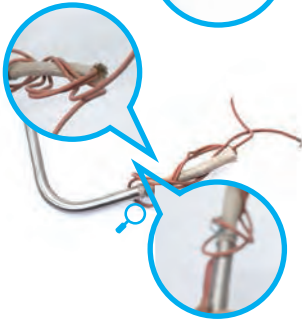

RFHE14

UNIVERSAL 'L' SHAPE ELEMENT - 220V
160W - 9,5mm O.D.
190mm long (total)



RFHE15

FRIDGE STEEL ELEMENT - 220V
160W - 9,5mm O.D.
125mm LONG



RFHE16

CREAMIC FREEZER ELEMENT - 220V
350W - 18mm O.D.
185mm LONG

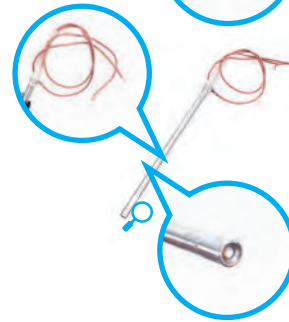

RFHE18

FRIDGE STEEL ELEMENT - 220V
180W - 9,5mm O.D.
125mm LONG



RFHE19

BAND HEATER - 220V
replacement option for any 350W steel or ceramic element - includes fitting instructions



RFHE20

FRIDGE ELEMENT - 220V
320W - 21mm O.D.
195mm LONG



RFHE30

FRIDGE ELEMENT - 12V/220V
160W - 17mm O.D.
125mm long



RPCK

ZERO/BARLOWS FREEZER ELEMENT - 220V
400W - 31mm O.D. 167mm long with mounting piece and fitted cord & plug

ICEMAKERS



4819 310 188397

ICEMAHER ASSEMBLY - 220V
WHIRLPOOL refrigerators,
also suitable for use on
GE, ARMANA and ADMIRAL
refrigerators
ORIGINAL PART



LG-5210JA3013B

TUBE (TAP TO FRIDGE)
LG refrigerators - GR-F258,
GR-G267, GR-L207



RT-LSV2K

WATER INSTALLATION KIT
UNIVERSAL APPLICATION

INSULATION

302313520

2 1/8 X 1/2 WALL INSULATION

3023201520

1/2 X 1/4 WALL INSULATION

3023203020

7/8 X 1/4 WALL INSULATION

3023205020

1/2 X 3/8 WALL INSULATION

3023206520

7/8 X 3/8 WALL INSULATION

3023208020

1-5/8 X 3/8 WALL INSULATION

3023211020

3/4 X 1/2 WALL INSULATION

3023212520

1 3/8 X 1/2 WALL INSULATION

3023216520

3/4 X 3/4 WALL INSULATION

3023218020

1-3/8 X 3/4 WALL INSULATION

RFINS-25834

2 5/8 X 3/4 WALL INSULATION

3023200520

1/4 X 1/4 WALL INSULATION

3023202020

5/8 X 1/4 WALL INSULATION

3023204020

1/4 X 3/8 WALL INSULATION

3023205520

5/8 X 3/8 WALL INSULATION

3023207020

1 1/8 X 3/8 WALL INSULATION

3023210020

1/2 X 1/2 WALL INSULATION

3023211520

7/8 X 1/2 WALL INSULATION

3023213020

1 5/8 X 1/2 WALL INSULATION

3023217020

7/8 X 3/4 WALL INSULATION

3023218520

1-5/8 X 3/4 WALL INSULATION

3023201020

3/8 X 1/4 WALL INSULATION

3023202520

3/4 X 1/4 WALL INSULATION

3023204520

3/8 X 3/8 WALL INSULATION

3023206020

3/4 X 3/8 WALL INSULATION

3023207520

1 3/8 X 3/8 WALL INSULATION

3023210520

5/8 X 1/2 WALL INSULATION

3023212020

1-1/8 X 1/2 WALL INSULATION

3023216020

5/8 X 3/4 WALL INSULATION

3023217520

1-1/8 X 3/4 WALL INSULATION

3023219020

2-1/8 X 3/4 WALL INSULATION



LAMPS



4812 134 28078

40W LAMP (PUSH-IN FIT)
WHIRLPOOL S20, S25BRSS



4840 000 00979

LAMP - 220V 15W
WHIRLPOOL refrigerators -
ART850, ART876, ART899



8009

FRIDGE LAMP - 110v 40W ES (E27)
40W ES (E27) suitable
for WHIRLPOOL 110V
refrigerators



LG-6912JB2004L

LAMP, INCANDESCENT-230V 40W
GR-A207, GR-B207, GR-B227, GR-L207, GR-P247



RG1

PYGMY LAMP - 220V 15W SES 15W SES (E14)



RG6

LAMP 220V - E12 15W
Fits DAEWOO & HAIER
refrigerators



RG8

FRIDGE LAMP, 220X
LED 0.6W E14
UNIVERSAL APPLICATION

MOTORS AND PARTS



2169000515

ZIEHL (EBM)COND FAN MOTOR 10W 220V
UNIVERSAL APPLICATION



2619000552

CONDENSOR FAN MOTOR 220V - 10 Watt
Universal application



2619001015

FAN MOTOR
16/14 Watt, 230Volt
Dimensions: 120x120x25



2619001015

EBM COND FAN MOTOR 16W
220V
UNIVERSAL APPLICATION



2619001515

EBM COND FAN MOTOR 25W
220V
UNIVERSAL APPLICATION



2619001552

CONDENSOR FAN MOTOR
220V - 25 Watt
Universal application



2619002015

EBM COND FAN MOTOR 34W
220V
UNIVERSAL APPLICATION



2619002052

CONDENSOR FAN MOTOR
220V - 34 Watt
Universal application



2619002552

COND FAN MOTOR 10W
PLUG IN EBM
UNIVERSAL APPLICATION



2619003052

COND FAN MOTOR 16W
PLUG IN EBM
UNIVERSAL APPLICATION



2619003552

COND FAN MOTOR 25W
PLUG IN EBM
UNIVERSAL APPLICATION



2619004552

FAN MOTOR
20/19 Watt, 230Volt
Dimensions: 120x120x38



2619004020

CONDENSOR FAN MOTOR
220V - 16 Watt
Universal application



4812 361 38103

AIR DIFFUSER & MOTOR



4819 361 78218

MOTOR - COND
ARG457



RAC-4Q045EA0194

EBM SPECIAL RECAM MOTOR
25W -220V
Commercial Refrigeration



RAC-BCALS26

HUSKY FAN S26
WITH BRACKET



RAC-HS220

EBM 220V FAN MOTOR -
HUSKY SPEC
Commercial refrigeration



RAC-PE250

220V CEILING FAN - 250mm
Replaces all popular ceiling
exhaust fans



REFM230

EVAPORATOR FAN MOTOR
KIT - 220V
Reversible motor with two
blades and instructions



REFM-DEFY

MOTOR, EVAP FAN DEFY
FROST FREE
MODEL: F64-10
DEFY REFRIGERATORS -
F350, F640, SS640

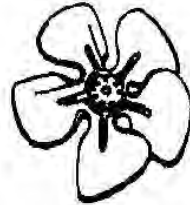

FAN BLADES

CONDENSER FAN MOTOR
BLADES - SUCKING/
BLOWING
RFMB1 - 200mm SUCKING
RFMB2 - 250mm SUCKING
RFMB3 - 170mm SUCKING
RFMB4 - 200mm BLOWING
RFMB5 - 250mm BLOWING
RFMB6 - 300mm BLOWING
RFMB7 - 300mm SUCKING
RFMB8 - 170mm BLOWING



RAC-BCALS26A

HUSKY FAN MOTOR WITH
BRACKET (NO FAN BLADE)



RAC-PE200

220V CEILING FAN - 200mm
Replaces all popular ceiling
exhaust fans



REFM220

220V EVAPORATOR FAN
MOTOR + BLADE
Universal application



REFM240

220V EVAPORATOR FAN
MOTOR
KIC / FRIDGEMASTER frost-
free refrigerators



REFM-DEFY2

MOTOR, EVAPORATOR
MODEL F C1 - 10
Suitable replacement for
REFM-DEFY



REFM-DEFY3

MOTOR, EVAPORATOR
DEFY FROST FREE
13V, 3.3W
4612AAA21
OEM REF: 3015914100



REFM-LG

MOTOR, EVAPORATOR
LG F/FREE FRIDGES
Suitable for most LG Frost free fridges



REFM-SAM

220V EVAPORATOR FAN MOTOR
KIC/SAMSUNG frost-free refrigerators



RFM07A

CONDENSOR FAN MOTOR
220V - 7 Watt
Universal application



RFM8025

FAN MOTOR
14/16 Watt, 230Volt
Dimensions: 80x80x25



RFM8038

FAN MOTOR
14/12 Watt, 230Volt
Dimensions: 80x80x38



TSS20

MOTOR DC-BLDC SENSOR
DRCP3020L
SAMSUNG REFRIGERATORS

OVERLOADS, RELAYS & KLIXONS



LG-6615JB2005A

CONTROL ASSEMBLY-DEF
LG refrigerators - GR-292QC,
GR-369GQ, GR-3895NQF,
GR-389STQ, GR-409GLQ



OVERLOAD KLIXON

RoP3 - 1/3 HP
RoP4 - 1/4 HP
RoP5 - 1/5 HP
RoP6 - 1/6HP



OVERLOAD KLIXON

SOLID STATE RELAY
ROP4SS - 1/4HP
ROP5SS - 1/5HP
ROP6SS - 1/6HP
ROP8SS - 1/8HP



RDT75

DEFROST TERMINATOR -
75degC 3A
suitable for use on kic frost-free models



RELAYS

ELECTROMAGNETIC RELAYS
- 220V
REL3 - 1/3HP
REL4 - 1/4HP
REL5 - 1/5HP
REL6 - 1/6HP
REL8 - 1/8HP



RIC20

SOLID STATE PUSH-ON RELAY - 220V
Suitable with compressors
- 1/12HP thru 1/2HP -
includes terminals



RIC21

SOLID STATE RELAY - 220V
Universal



RIC25

RELAY/OVERLOAD COMBINATION KIT - 220V
Suitable with compressors - 1/5HP, 1/6HP, and 1/8HP



RML55

CLIP-ON DEFROST THERMOSTAT
Normally open
opens @ 13degc, closes @ 2degC



RIC23

RELAY/OVERLOAD COMBINATION KIT - 220V
Suitable with compressors - 1/3HP and 1/4HP



RIC32

SOLID STATE PUSH ON RELAY - 220V
Suitable with compressors 1/12HP thru 1/2HP

PUMPS: COOLER ICE MAKER

4233101018

ICEMAKER PUMP
Large



4233101518

ICEMAKER PUMP
Small

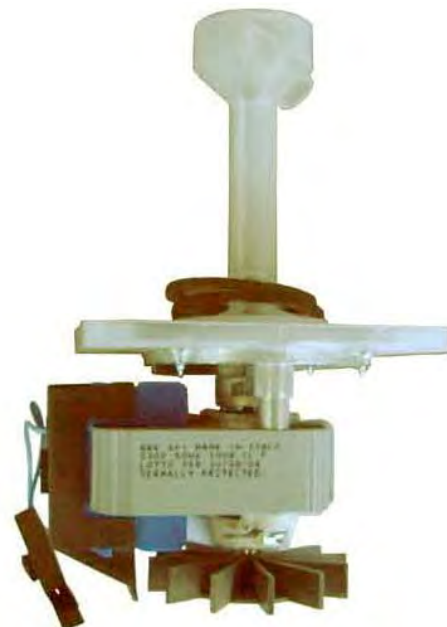

REFRIGERANTS & FLUSHING AGENTS

2821101020

5LTR R141B SOLVENT

2821102020

R134A REFRIGERANT 280G CAN

2821103020

RGR600A 420G SMALL TIN

2821400420

R22 REFRIGERANT 3.4KG DISPOSACAN

2821401020

R22 REFRIGERANT DISP/CAN 13,6K

2821402020

R134A REFRIGERANT 13,6KG D/CAN

2821403020

R406A REFRIGERANT 11.3KG DISPOSACAN

2821404020

R410 REFRIGERANT DIS/CAN 11.3KG

2821405020

R507 REFRIGERANT DISP, 11.4KG

2821406820

R141B FLUSHING AGENT 13.6KG DISPOSACAN

RGR22-800g

R22 REFRIGERANT ROOG CAN

SERVICE ACCESSORIES



RCP3

EPOXY HEAT SEAL "GREEN STICK"
SUITABLE FOR MICRO LEAK REPAIRS

RINF2

POLYURETHANE FOAM 2 PART
EXPANDABLE
POLYURETHANE FOAM

2821101520

R600A 6.5KG DISPOSOCAN

2821102520

R134A REFRIGERANT 800G CAN

2821104020

1LTR R141B SOLVENT

2821400520

R22 REFRIGERENT 34KG DISPOSACAN

2821401520

R134A REFRIGERANT 3.4KG DISPOSACAN

2812402520

R404A REFRIGERANT DISP, 10.9KG

2821403520

R407 REFRIGERANT DISP, 11.3KG

2821404520

R408 REFRIGERANT DISP, 10.9KG

2821406520

R141 DISPOSOCAN 6.8KG

2821700520

R22 REFRIGERANT 57KG CYLINDER



RINF1

INSULATING FOAM 750 ML
EXPANDABLE
POLYURETHANE FOAM



SWITCHES



4812 413 68015

LIGHT SWITCH
WHIRLPOOL refrigerator
-WVG30IX



LG-6600JB1002F

SWITCH PUSH-BUTTON
LG refrigerator - GR-392BF



RCF-LP

LAMP HOLDER WITH FLOAT SWITCH
KIC/DEFY chest freezers
- activated when lid is opened



RS10

LIGHT SWITCH
Square push fit



RS20

LIGHT SWITCH
Suitable with most KIC
fridge/freezers
ORIGINAL PART

THERMOMETERS



RF THERM

HANGING THERMOMETER
Suitable with all
refrigeration



RT-PT1005

POCKET THERMOMETER
Range -40°C to 70°C
protective plastic sleeve

THERMOSTATS



1001000512

SINGLE DOOR THERMOSTAT - KIT
DANFOSS, 1200mm capillary



1001000520

UNITHERM SINGLE DOOR THERMOSTAT KIT
UNIVERSAL APPLICATION



1001001512

DOUBLE DOOR THERMOSTAT KIT
DANFOSS - 1200mm
capillary



1001001520

UNITHERM DOUBLE DOOR THERMOSTAT KIT
UNIVERSAL APPLICATION



1001001528

DOUBLE DOOR THERMOSTAT - KIT
RANCO - K59 L1102,
1200mm capillary



1001002012

DANFOSS D/DOOR STAT SEMI-DEFR
DANFOSS - 077B7002



1001002028

DOUBLE DOOR THERMOSTAT ONLY
RANCO - K59 P1685,
1200mm capillary



1001003012

DANFOSS FRZ STAT PASSIVE SIGNAL
DANFOSS- 077B7007



1001003020

UNITHERM FREEZER THERMOSTAT KIT
UNIVERSAL APPLICATION



1001003512

FREEZER THERMOSTAT - KIT
DANFOSS - A90U22.11
2000mm capillary without signal



1001003028

FREEZER THERMOSTAT - KIT
RANCO - K50 P1126,
1200mm capillary



1001 004 012

DANFOSS BEVERAGE T/STAT KIT
Universal application



1001004020

UNITHERM BEVERAGE THERMOSTAT KIT
UNIVERSAL APPLICATION



1001004028

BEVERAGE COOLER THERMOSTAT - KIT
RANCO - K50 P1127,
1200mm capillary



100100528

SINGLE DOOR THERMOSTAT - KIT
RANCO - K50 P1110,
1200mm capillary



1001609528

AMBIENT THERMOSTAT
Suitable with cold rooms / cold storage



4812 271 48002

THERMOSTAT
WHIRLPOOL refrigerator
-WVG30IX



4812 908 00600

C/FREEZER THERMOSTAT VARIFREEZE
Universal application



LG-6930JR2002B

THERMOSTAT ASSEMBLY.
GR-249, GR-259, GR-289,
GR-329, GR-379



RADD3

**FROST FREE AIR SENSING
THERMOSTAT - LOOSE**
Suitable with frost free
double door fridge /
freezers



RADD6

AIR SENSOR THERMOSTAT
DECO BU252 - fits various
makes of frost-free
refrigerators



RADF

**SEMI-AUTO DEFROST
THERMOSTAT - LOOSE**
Short capillary

TIMERS: DEFROST



RFDT220B

PARAGON DEFROST TIMER
- 220V
8 HOUR CYCLE, 21 MINUTE
DEFROST

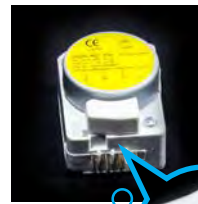

RFDT-KIL

DEFROST TIMER - KIL355
8 HOUR CYCLE, 30 MINUTE
DEFROST



RFDT-SAN

SANKYO DEFROST TIMER -
220V
8 Hour 30 min defrost
timer - suitable for all
KIC,SAMSUNG and HITACHI
frost-free models

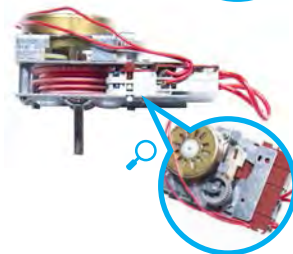

RFDT-UNI

UNIVERSAL DEFROST TIMER
- 220V
6 Hour cycle, 20 minute
defrost

TRAYS: ICE & DRIP



D1522877

COMPRESSOR DRIP TRAY
ALUMINIUM.
Suitable with most domestic
compressors.

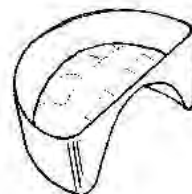

RDRTRAY

COMPRESSOR DRIP TRAY
Suitable with most domestic
compressors

VALVES



4210534

**DOUBLE WATER INLET VALVE
- 220V**
WHIRLPOOL refrigerators
USA models, also suitable
for use on ARMANA, GE
refrigerators
ORIGINAL PART

WATER FILTERS



4812 817 29632

CARTRIDGE - WATER FILTER
REPLACEABLE CARTRIDGE
FOR P/N 4812 817 28358
Alternate Stock Code:
WP015



LG-5231JA2006F

FILTER ASSEMBLY, WATER
LG REFRIGERATORS



LG-5231JA2012B

FILTER ASSEMBLY - HEAD
FITS LG REFRIGERATOR



RWF001

**IN LINE WATER FILTER
ASSEMBLY**
CAN REPLACE ALL INLINE
WATER FILTERS. SUPPLIED
WITH FITTINGS



RWF002

**IN LINE WATER FILTER EF-
9603**
UNIVERSAL INLINE WATER
FILTER. SUPPLIED WITH
FITTINGS



RWF003

**IN LINE WATER FILTER EF-
9603**
Suitable for: DEFY, BOSCH,
AEG



RWF004

SAMSUNG WATER FILTER
INTERNAL FITTING



RWF006

LG WATER FILTER
OEM REF: 5231JA2002A



05

SMALL APPLIANCES, GEYSERS & URNS





CEILING FANS



RCAP3

CAPACITOR 0.5 + 1.2MFD 450V
Universal application



KSW-ON

PULL SWITCH - ON/OFF
Universal application



KSW-PL

PULL SWITCH - 3 SPEED
Universal application

CLEANING AGENTS



HSC 3

KETTLE & STEAM IRON CLEANER - 210G
Dissolves lime build-up in irons, kettles and urns

CONNECTORS

HCE03

HEATER GLASS BAR CERAMIC END
14mm I.D. - Square back suitable with CAPIL, TEDELEX, HAZ AND CONCORDE

HCE04

HEATER GLASS BAR CERAMIC END
10,8mm I.D. - square back suitable with IDEAL, PACE, FLOHEAT, HAZ, and SAFEWAY

HCE05

HEATER GLASS BAR CERAMIC END
10,8mm I.D. - small round back

KPC15

SINGLE PORCELAIN CONNECTOR
5 AMP max.

KPC115

SINGLE PORCELAIN CONNECTOR
15 AMP max.

KPC215

DOUBLE PORCELAIN CONNECTOR
15 AMP max.

KPC26

DOUBLE PORCELAIN CONNECTOR
6 AMP max.



KPC35

TRIPLE PORCELAIN CONNECTOR
5 AMP max.



KPC315

TRIPLE PORCELAIN CONNECTOR
15 AMP max.



CERAMIC HEATER BAR

HC B11	9" CERAMIC HEATER BAR 229mm - 700W VERTICAL SCREW MOUNT
HC B11A	9" - 9,5" CERAMIC HEATER BAR 229 TO 241mm - 700W HORIZONTAL SCREW MOUNT
HC B12	9,5" CERAMIC HEATER BAR 241mm - 750W VERTICAL SCREW MOUNT
HC B13	10" CERAMIC HEATER BAR 254mm - 900W VERTICAL SCREW MOUNT
HC B13A	10" - 10,5" CERAMIC HEATER BAR 254 TO 267mm - 900W HORIZONTAL SCREW MOUNT
HC B14	10,5" CERAMIC HEATER BAR 367mm - 950W VERTICAL SCREW MOUNT
HC B15	381mm CERAMIC HEATER BAR 1000W - DIRECT REPLACEMENT FOR 381mm QUARTZ GLASS HEATER BAR
HC B16	350mm CERAMIC HEATER BAR 900W - PUSH-IN TERMINAL SUITABLE WITH ESTIA HEATERS
HC B18	250mm CERAMIC HEATER BAR 750W - PUSH-IN TERMINALS SUITABLE WITH ESTIA HEATERS
HC B20	13" CERAMIC HEATER BAR 1200W - 330mm VERTICAL SCREW MOUNT
HC B22	11" CERAMIC HEATER BAR 700W - 279mm VERTICAL SCREW MOUNT
HC B22A	11,5mm CERAMIC HEATER BAR 293mm - 1000W VERTICAL SCREW MOUNT
HC B23	7" CERAMIC HEATER BAR 500W - 178mm VERTICAL SCREW MOUNT
HC B24	8,5" CERAMIC HEATER BAR 216mm - 650W VERTICAL SCREW MOUNT
HC B25	175mm CERAMIC HEATER BAR, DIAMOND BRACKET MOUNT
HC B26	220mm CERAMIC HEATER BAR, DIAMOND BRACKET MOUNT
HC B27	250mm CERAMIC HEATER BAR, DIAMOND BRACKET MOUNT
HC B28	220mm CERAMIC HEATER BAR, ESTIA PUSH-ON CONNECTORS
HC B29	270mm CERAMIC HEATER BAR, SUNBEAM HORIZONTAL SCREW MOUNT
HC B30	265mm CERAMIC HEATER BAR, SUNBEAM HORIZONTAL SCREW MOUNT
HC B31	380mm CERAMIC HEATER BAR, SUNBEAM WITHOUT MOUNTS



QUARTZ HEATER BAR

HAZJ0847	350MM LONG - 11MM THICK - 750W COZEE COMFORT CCR101, TEDELEX 4050, HAZ CCR103
HB01	686MM LONG - 8,5MM THICK - 750W DIMPLEX
HB02	565MM LONG - 8,5MM THICK - 100W PINTO HEATGLO, CAPIL EXECUTIVE 2000
HB03	640MM LONG - 11,8MM THICK - 1200W CAPIL EXECUTIVE 2400, PINTO HEATRAY 2000W, HOMECRAFT 2400W
HB04	381MM LONG - 10MM THICK - 800W IDEAL, PACE, FLOHEAT, HAZ HZ409, HAZ 410, 401, 403, SAFEWAY SW401
HB04-B	381MM LONG - 10MM THICK - 800W (INCLUDING CLIPS) IDEAL TWO BAR HEATERS
HB04-C	381MM LONG - 10MM THICK - 1000W (INCLUDING ENDS) IDEAL TWO BAR HEATERS
HB05	320MM LONG - 11,5MM THICK - 800W CAPIL, DIPLOMAT, PINTO MAXIGLO, PINTO NEWGLO
HB06	400MM LONG - 12MM THICK - 800W CAPIL PRESIDENT, ALFA NOVEX, CONCORDE 2400, COZEE COMFORT 25C, HOMECRAFT FAN HEATER
HB07	500MM LONG - 10MM THICK - 1000W IDEAL LONG BAR
HB08	480MM LONG - 12MM THICK ESTIA FIREPLACE
HB09	470MM LONG - 9,5MM THICK - 1000W VARIOUS HEATERS
HB10	540MM LONG - 800W VARIOUS HEATERS
HB12	420MM LONG - 10,9MM THICK - 1100W GOLDAIR, AURORA
HB13	220MM LONG - 400W VARIOUS HEATERS
HB14	220MM LONG - 600W - HALOGEN VARIOUS HEATERS
HGA87969	540MM LONG - 13,5MM THICK - 1200W GEC 2400, CAPIL 2400
HZH19	480MM LONG - 13,5MM THICK - 1100W CAPIL CBFH2200, TEDELEX FH1200, CAPIL FAN HEATER
HZJ48	315MM LONG - 12MM THICK - 500W (WIRE ENDS) TEDELEX XFH1200, CAPIL CFH1500
HZM115	381MM LONG - 12MM THICK - 1000W CAPIL 2600, SWIFT 200, HAZ DE LUXE 2000, CONCORDE CD2000, TEDELEX FH1200



PLUG TOPS



SNPT

3 PIN NYLON PLUGTOP -
WHITE
15AMP max.



SNPT-R

3 PIN PLUGTOP
RUBBER 16 AMP.



ELEMENTS



MG1

MINIGEZA - WATER HEATER
SABS approved water
heating solution

GEYSER ELEMENTS



KEG1

GEYSER ELEMENT - 1500W
With pocket



KEG2A

UNITHERM GEYSER ELMT
2KW W/PKT



KEG3A

UNITHERM GEYSER ELMT
3KW W/PKT



KEG4A

UNITHERM GEYSER ELMT
4KW W/PKT
With pocket



KEG5A

UNITHERM GEY.ELMNT H/W
2KW
Hard water



KEG6A

UNITHERM GEY.ELMNT H/W
3KW
Hard water - with pocket



KEG10

**SADIA GEYSER ELEMENT -
3000W
416mm long**



KEG11

**GEYSER ELEMENT - 650W
With pocket**



KEG13

**VERTICAL GEYSER ELEMENT
- 3000W
Soft water**



KEG14

**VERTICAL GEYSER ELEMENT
- 4000W
Soft water**



KEG15A

**UNITHERM H/W GEY ELEM
4KW W/P**



KEG16A

**UNITHERM GEYSER ELEMENT
2KW**



KEG17A

**UNITHERM KWIKHOT GEY
ELEM 3KW**



KEG18

**KWIKHEAT GEYSER ELEMENT
- 4000W
With pocket**



KEG19

**GEYSER ELEMENT
HORIZONTAL - 2000W
Without pocket**



KEG20

**GEYSER ELEMENT
HORIZONTAL - 3000W
Without pocket**



KEG21

**GEYSER ELEMENT
HORIZONTAL - 4000W
Without pocket**



KEG23

**ELEMENT, 3X1.33KW
350MM H/WATR**



KEG24A

UNITHERM KWIKOT SPIRAL
EMT 4KW



KEG25A

UNITHERM KWIKOT SPIRAL
EMT 3KW
With pocket



KEG26A

UNITHERM KWIKOT SPIRAL
EMT 2KW
KWIKHEAT geysers



KEG27

MINI GEYSER ELEMENT -
1500W
Without pocket



KEG28

FUCHS ELEMENT - 3000W
468MM LONG
FUCHS heavy-duty geysers



KEG31A

GEYSER ELEMENT - 2000W
Fits fibre glass geysers



KEG32A

UNITHERM GEYSER ELEMENT
3KW
Fits fibre glass geysers



KEG33

GEYSER ELEMENT - 2000W
Fits FUCHS heavy-duty geysers



KEG34

FUCHS H/DUTY ELMNT
340MM 1.5KW



KEG35

UNITHERM H/W GEY ELEM
2KW W/P
HARD WATER - WITH
POCKET



KEG36

UNITHERM GEYSER ELEMENT
3kW
HARD WATER - WITH
POCKET

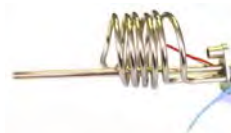

KEG49A

UNITHERM GEYSER ELEMENT
3kW
SUITABLE FOR FRANKE
GEYSERS



KEG50A

**ELEMENT, 3x1.33KW
350MM H/WATR
SUITABLE FOR FRANKE
GEYSERS**



KEG51A

**UNITHERM GEYSER ELMT
4KW W/PKT
SUITABLE FOR FRANKE
GEYSERS**



KEG51AN

**ANODE, FRANKE 3KW -
580MM**



KEG53

**MINI BOILER 1.5KW
(URN BOSS)**



KEG55

**UNITHERM GEY.ELMMT H/W
2KW
WITHOUT POCKET**



KEG57

**HYDROBOIL ELEMENT 650W
KIT**



KEG58

**HYDRBOIL ELEMENT 1.5KW
SCREWON**



KEG60

**ZIP HYDROBOIL 2400W
ELEMENT
FRANKE hydroboil**



KEG77

**UNITHERM GEYSER ELEMNT
4KW - HARD WATER WITH
POCKET**



KEG7

**SADIA GEYSER ELEMENT -
1500W
340mm long**

KEG8

**SADIA GEYSER ELEMENT -
2000W
340mm long**

KEG9

**SADIA GEYSER ELEMENT -
2000W
416mm long**

KEG77

**UNITHERM GEYSER
ELEMENT - 4KN HARD
WATER - WITH POCKET**

HEATER: OIL ELEMENTS



HOE-C15

OIL HEATER ELEMENT -
1500W (METRIC THREAD)
Suitable with 5, 6 and 7
fin oil heaters

HOE-C20

OIL HEATER ELEMENT -
2000W (METRIC THREAD)
Suitable with 8, 9 and 10
fin oil heaters

HOE-C25

OIL HEATER ELEMENT -
2500W (METRIC THREAD)
Suitable with 11, 12 and 13
fin oil heaters

HOE-C30

OIL HEATER ELEMENT -
3000W (METRIC THREAD)
Suitable with 14, 15 and 16
fin oil heaters

HOE15

OIL HEATER ELEMENT -
2 X 750W
Suitable with 5, 6 and 7
fin oil heaters

HOE20

OIL HEATER ELEMENT -
2 X 1000W
Suitable with 8, 9 and 10
fin oil heaters

HOE30

OIL HEATER ELEMENT -
2 X 1500W
Suitable with 14, 15 and 16
fin oil heaters



ELEMENTS: KETTLES



AZF1389

STANDARD KETTLE ELEMENT
HAZ kettle - HZ202,
HZ203 late suitable with
CONCORDE and SAFEWAY



KE25

**JUG KETTLE ELEMENT -
2,4KW**
Reversed pins, PINEWARE
kettle - late models



KE35

**UNIVERSAL JUG KETTLE
ELEMENT - 2,4KW**
Suitable with many makes
of jug kettles



KE45

**ELEMENT, KETTLE IDEAS
(RECESSED)**
Suitable with many makes
of jug kettles



KE739

**UNIVERSAL KETTLE ELEMENT
AND CORD - 2,4KW**
Suitable with many makes
of jug kettles

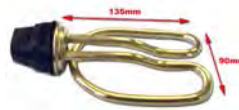

KE740C

**UNITHERM UNIVERSAL
KETTLE ELEMENT - 2,4KW**
Suitable with many makes
of jug kettles

ELEMENTS: GASKET, SPANNER



HOE05

ELEMENT GASKET
Suitable with oil heater
and geyser elements



KEGSP

GEYSER ELEMENT SPANNER
Fits all domestic geyser
elements



KEGSP-2

TUBE SPANNER
2" HEAVY DUTY



KEUSP

ELEMENT SPANNER
Suitable for use on urn
and geyser elements



KEW1

**KETTLE ELEMENT WASHER
SET**
Pack of 5 neoprene
and fibre washers

ELEMENTS: GRILLER, HOT TROLLEY

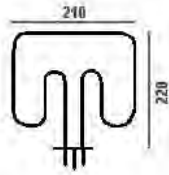

KBBE

FLAT PIN GRILLER ELEMENT
- 1500W
BERDA griller - MAXI tv braai

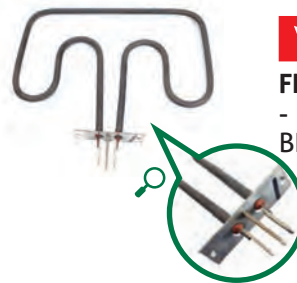

KBBE2

FLAT PIN GRILLER ELEMENT
- 1200W
BERDA griller - MINI tv braai

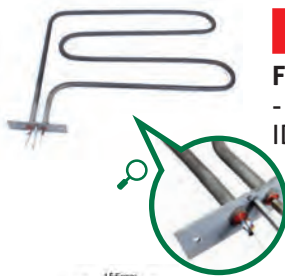

KBBE3

FLAT PIN GRILLER ELEMENT
- 1800W
IDEAL griller - multi-meal



KBBE5

ROUND PIN GRILLER ELEMENT
BERDA griller - MAXI tv braai

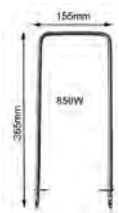

KBBE9

ELEMENT - 850W
NU-TEC compact oven -
NCO-022



KBBE10

GRILL ELEM. 550W
MINI OVEN
NU-TEC compact oven -
NCO-022

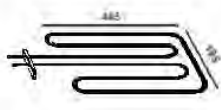

KHRE

FLAT PIN GRILLER ELEMENT
- 1500W
Suitable with GENERAL
ELECTRIC and DEFY hot
rocks early

FOOD MIXERS

KWCAR7

CARBON BRUSH - PAIR
KENWOOD food mixer - 701



KWCAR9

CARBON BRUSH - PAIR
KENWOOD food mixer - 901

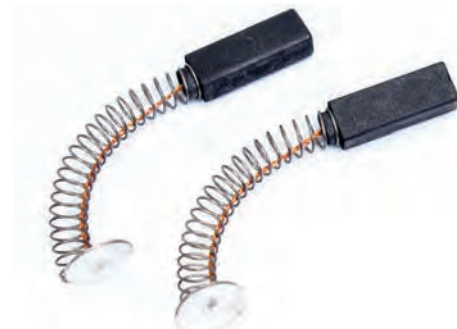



HEATER OIL



HOE04

OIL FOR OIL HEATERS - 500ML
Can be used on all oil heaters

HOT PLATES



S300

EVAPORATOR PLATE - 300 X 6" SPIRAL PLATE
PINEWARE hotplate - all spiral models



SER4

HIGH TEMPERATURE ENERGY REGULATOR
Suitable with most spiral hot plates



SER5

2 POLE ON/OFF SWITCH
Suitable for IDEAS hotplates



SP29

SOLID PLATE 145MM
NU-TEC mini oven NCO-022



SP30

SOLID PLATE 180MM
NU-TEC mini oven NCO-022



SER15A

UNIVERSAL ENERGY REGULATOR
FOR MINI OVEN PLATES



SER20

OVEN REGULATOR
BHICE / GRILL
FUCHSWARE FC400G

MICROTEMPS

KMT072

72 deg C
SUITABLE FOR USE ON FOOD MIXERS, HAIR DRYERS, COFFEE PERCOLATORS, WATER HEATERS, VACUUM CLEANERS, STORAGE HEATERS & FOOD WARMERS

KMT077

77 deg C
SUITABLE FOR USE ON FOOD MIXERS, HAIR DRYERS, COFFEE PERCOLATORS, WATER HEATERS, VACUUM CLEANERS, STORAGE HEATERS & FOOD WARMERS

KMT096

96 deg C
SUITABLE FOR USE ON FOOD MIXERS, HAIR DRYERS, COFFEE PERCOLATORS, WATER HEATERS, VACUUM CLEANERS, STORAGE HEATERS & FOOD WARMERS

KMT098

98 deg C

SUITABLE FOR USE ON FOOD MIXERS, HAIR DRYERS, COFFEE PERCOLATORS, WATER HEATERS, VACUUM CLEANERS, STORAGE HEATERS & FOOD WARMERS

KMT167

167 deg C

SUITABLE FOR USE ON SANDWICH TOASTERS, HEATED ROLLERS, STORAGE HEATERS & COMBINATION WASHER/ DRYERS

KMT229

229 deg C

SUITABLE FOR USE ON DEEP FAT FRYERS, PAINT STRIPPERS, FILTER COFFEE MAKERS & CAPPUCINO MAKERS

KMT121

121 deg C

SUITABLE FOR USE ON FOOD MIXERS, HAIR DRYERS, COFFEE PERCOLATORS, WATER HEATERS, VACUUM CLEANERS, STORAGE HEATERS & FOOD WARMERS

KMT192

192 deg C

SUITABLE FOR USE ON SANDWICH TOASTERS, HEATED ROLLERS, STORAGE HEATERS & COMBINATION WASHER/ DRYERS

KMT240

240 deg C

SUITABLE FOR USE ON DEEP FAT FRYERS, PAINT STRIPPERS, FILTER COFFEE MAKERS & CAPPUCINO MAKERS

KMT144

144 deg C

SUITABLE FOR USE ON SANDWICH TOASTERS, HEATED ROLLERS, STORAGE HEATERS & COMBINATION WASHER/ DRYERS

KMT216

216 deg C

SUITABLE FOR USE ON DEEP FAT FRYERS, PAINT STRIPPERS, FILTER COFFEE MAKERS & CAPPUCINO MAKERS

PRESSURE COOKER PARTS



HPC 1

SEALING RING - 'V' SHAPE

DURAWARE pressure cooker - all models; TEDELEX pressure cooker - stainless-steel models O.D.- 240mm

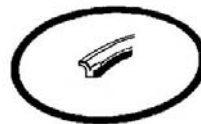

HPC 2

SEALING RING - 'V' SHAPE

TEDELEX pressure cooker - all aluminium base models with coloured lids



HPC 3

SEALING RING - 'V' SHAPE

PRESTO pressure cooker - 70, 80, 706B, 708B, 900, 910, 1000 O.D.- 260mm



PPC60002

SEAL

Seal for 10 litre Pressure Cooker



▶ **PPC60031**

COVER HANDLE ASSEMBLY
THERMOSTAT
PRESTIGE - ALU DIX



▶ **PPC60068**

BODY HANDLE
ASSEMBLY - DELUXE



▶ **PPC60097**

AUXILLARY HANDLE
ASSEMBLY - 8.5 / 11 / 13
LTR



▶ **PPC60097**

LID SLIDE KNOB
TEDELEX PRESSURE COOKER
-TPC04/07/11



▶ **PPC60117**

PRESSURE INDICATOR
SAFETY PLUG



▶ **PPC60423**

WEIGHT VALVE ASSEMBLY
PRESTIGE PRESSURE
COOKERS



▶ **PPC62703**

SEALING RING
PRESTIGE 7.5L - SS QUICK &
EASY



▶ **PPC96510**

METALLIC SAFETY PLUG
PRESTIGE - POPULAR,
SUPREME, ULTIMATE &
REGULAR COOKERS



▶ **PPC96513**

WEIGHT VALVE ASSEMBLY
PRESTIGE PRESSURE
COOKERS - MOST MODELS

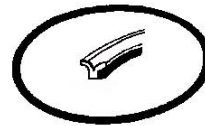

▶ **PPC96514**

SEALING RING - PRESTIGE
POPULAR
PRESTIGE POPULAR MODELS
- 4 LITRE, 5 LITRE, 6 LITRE

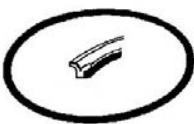

▶ **PPC96515**

SEALING RING - PRESTIGE SENIOR
PRESTIGE - 7.5L, 10L, 12L, SENIOR
PRESSURE, ULTIMATE, POPULAR,
DELUXE, DELUXE PLUS, 7.5L,
8.5L, 10L, 11L, 12L, 13L, SENIOR
PRESSURE PANS, JUMBO PAN



▶ **PPC96522**

AUX HANDLE - JUNIOR
PRESTIGE POPULAR - 2L,
3L, 4L, 5L, 5.5L, 6L, 6.5L,
STAINLESS STEEL DELUXE 2L



PPC96520

BODY HANDLE - JUNIOR
PRESTIGE POPULAR - 2L, 3L, 4L, 5L, 5.5L, 6L, 6.5L, JUNIOR DEEP PRESSURE PAN



PPC96525

BODY HANDLE
PRESTIGE SENIOR - 7.5L, 10L, 12L, DEEP PRESSURE PAN



PPC96526

COVER HANDLE - SENIOR
PRESTIGE POPULAR - 7.5L, 10L, 12L, DEEP PRESSURE PAN



PPC96527

AUX HANDLE - SENIOR
PRESTIGE POPULAR - 7.5L, 10L, 12L, DEEP PRESSURE PAN



PPC66606

SAFETY PLUG + GROMME
PRESTIGE 5.5L SS



PPC66607

PRESSURE REGULATOR ASSEMBLY
PRESTIGE - 5.5L SS QNE



PPC66608

COVER HANDLE ASSEMBLY
PRESTIGE - 5.5L SS QNE



PPC66609

BODY HANDLE
PRESTIGE - 5.5L SS QNE



PPC66610

AUX HANDLE ASSEMBLY
PRESTIGE - Q & E SS 5.5L

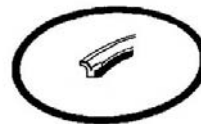

PPC66611

SEALING RING
PRESTIGE 7.5L - MODEL - 36111, 38111, 76505, 78505



PPC66613

REGULATOR
PRESTIGE - ALUMINIUM COMPACT 7.5L



PPS32

SEALING RING - 'V' SHAPE
PRESTIGE pressure cooker - 'high dome' O.D.- 245mm



TPC10

BODY HANDLE
TEALEX PRESSURE COOKER - TPC04/07/11



THERMOSTAT SWITCHES



HDR858
DOUBLE 2 POLE ON/OFF SWITCH
Dual illuminated - red



HDR860
SWITCH DBL/PL ILL ON/OFF GREEN



HDS650
2 POLE ON/OFF SWITCH
Non-illuminated - black



HDS800
SWITCH, ON/OFF
Various halogen heaters



HS5
ON/OFF SWITCH
IDEAL heaters



HTH65
ADJUSTABLE THERMOSTAT
35 degC - yellow shaft
suitable with panel heaters



HTH66
ADJUSTABLE THERMOSTAT
70degC - grey shaft
suitable with oil heaters



KCMP3
CONT.MASTER - FRY PAN IDEAL / ELECTRICAL WOK
Electric frying pans - HAZ, PINEWARE, SALTON, SAFEWAY, IDEAL, AIM, IDEAS, GOLDAIR, MAGICLINE



KCSB
STRIX CONTROL SWITCH BASE
Various jug kettles



KCSW
STRIX HANDLE CONTROL SWITCH
Various jug kettles



KEU08
URN THERMOSTAT - VB3
Suitable with pocket elements



KEU12
URN THERMOSTAT - 120°C (4 CONTACT)
Fits various makes of urns including SUNBEAM



KGT7
SATCHWELL GEYSER THERMOSTAT
Suitable with 7" pocket elements

KGTTSE
KWIKHEAT GEYSER THERMOSTAT
KWIKHEAT geysers - all recent models

KVKF7
SATCHWELL GEYSER THERMOSTAT - VKF7
Suitable with 7" pocket elements



KGT11
SATCHWELL GEYSER THERMOSTAT
Suitable with 11" pocket elements

KVKF11
SATCHWELL GEYSER THERMOSTAT - VKF11
Suitable with 11" pocket elements



SRR3
MINI ON/OFF SWITCH - ILLUMINATED
Universal application



SW14WF
CENTRE-OFF TWO WAY ROCKER SWITCH
Universal application



SW15TAF
ON/OFF ROCKER SWITCH
Universal application



SW15TBF
ON/OFF ROCKER SWITCH
White body, black rocker, chrome trim



SW15TRF
ON/OFF ROCKER SWITCH
White body, red rocker, chrome trim



SW15TWF
ON/OFF ROCKER SWITCH
White body, white rocker, chrome trim



SW16
ON/OFF SWITCH
Universal application



SW17TAF
ON/OFF ROCKER SWITCH
White body, amber rocker - illuminated, chrome trim



SW25WF
ON/OFF SWITCH (0-1) NON-ILLUMINATED
Universal application



SWITCHES

PART NUMBER	DESCRIPTION	BODY COLOUR	ROCKER COLOUR	TRIM	LIGHT
SW14WF	14 WF - CENTRE OFF	WHITE	WHITE	NO TRIM	
SW15AF	15 AF - ON/OFF	AMBER	WHITE	NO TRIM	ILLUMINATED
SW15BF	15 AF - ON/OFF	BLACK	WHITE	NO TRIM	
SW15RF	15 TRF - ON/OFF	RED	WHITE	NO TRIM	
SW15TAF	15 TAF - ON/OFF	AMBER	WHITE	CHROME	
SW15TBF	15 TBF - ON/OFF	BLACK	WHITE	CHROME	
SW15TRF	15 TRF - ON/OFF	RED	WHITE	CHROME	
SW15TWF	15 TWF - ON/OFF	WHITE	WHITE	CHROME	
SW15WF	15 WF - ON/OFF	WHITE	WHITE	NO TRIM	
SW16AF	16 AF - CHANGE OVER	AMBER	WHITE	NO TRIM	
SW16COB	MINI CHANGE OVER	BLACK	BLACK	NO TRIM	
SW16COW	MINI CHANGE OVER	WHITE	WHITE	NO TRIM	
SW16RF	16 RF - CHANGE OVER	RED	WHITE	NO TRIM	
SW16TAF	16 TAF - CHANGE OVER	AMBER	WHITE	CHROME	
SW16TBF	16 TBF - CHANGE OVER	BLACK	BLACK	CHROME	
SW16TRF	16 TRF - CHANGE OVER	RED	WHITE	CHROME	
SW16TWF	16 TWF - CHANGE OVER	WHITE	WHITE	CHROME	
SW16WF	16 WF - CHANGE OVER	RED	WHITE	NO TRIM	
SW17AF	17 AF - ON/OFF	AMBER	WHITE	NO TRIM	ILLUMINATED
SW17RF	17RF ON/OFF	RED	WHITE	NO TRIM	ILLUMINATED
SW17TAF	17 TAF - ON/OFF	AMBER	WHITE	CHROME	ILLUMINATED

PART NUMBER	DESCRIPTION	BODY COLOUR	ROCKER COLOUR	TRIM	LIGHT
SW17TRF	17 TRF - ON/OFF	RED	WHITE	CHROME	ILLUMINATED
SW25AF	25 AF - ON/OFF	AMBER	BLACK	NO TRIM	
SW25BF	25 BF - ON/OFF	BLACK	BLACK	NO TRIM	
SW25WF	25 WF - ON/OFF	WHITE	BLACK	NO TRIM	
SW26AF	26 AF - CHANGE OVER	AMBER	BLACK	NO TRIM	
SW26BF	26 BF - CHANGE OVER	BLACK	BLACK	NO TRIM	
SW26RF	26 RF - CHANGE OVER	RED	BLACK	NO TRIM	
SW27AF	27 AF - ON/OFF	AMBER	BLACK	NO TRIM	ILLUMINATED
SW27RF	27 RF - ON/OFF	RED	BLACK	NO TRIM	ILLUMINATED



URN TAPS: TAPS, TAP WASHERS

KEU07

1/2" URN TAP
Complete with chrome



KEU07A

1/2" URN TAP WASHER
Suitable with part number
KEU07







MICROWAVE OVENS



BELTS



SNMWBA
FLAT DRIVE BELT
National microwave - most models



SNMWBB
SQUARE SUB BELT
National microwave - most models

HIGH VOLTAGE CAPACITORS

SCAP95

0.95UF 2100V



SCAP114

1.14UF 2100V



SCAP100

1.0UF 2100V

SCAP120

1.2UF 2100V

SCAP110

1.1UF 2100V

RCD3055

COMM.DRIER 5/8 SWEAT ON

COUPLINGS



LG-4370W1A004C

TURNTABLE COUPLING
LG MICROWAVES - MP9482S,
MP9483S, MP9485S,
MP9486S, MP9488S



LG-5889W1A005B

ROTATING RING ASSEMBLY
MS4042DP
LG microwave - MS-4042DP



LG-5889W2A013A

TURNTABLE RING
LG microwave - MS543XD
ORIGINAL PART



LG-5889W2A014A

RING ASSEMBLY
LG MICROWAVE - MS3045N,
CWHQ5AF, MS-3045NB,
MS-3047GB



LG-5889W2A015A

ROTATING RING ASSEMBLY
LG microwave - MC6644BO,
MC8083DS

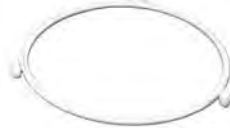

SMRR1

**TURNTABLE RING - 220mm
DIAMETER**
Universal application



SMRR5

**TURNTABLE RING - 220mm
DIAMETER**
Universal application



SMWC1

**CLOVER COUPLER - SHORT
SHAFT**
DAEWOO microwave -
KOR115B, KOR1005
KIC microwave - MWS290
OEM REF: 4418D10032



SMWC2

**CLOVER COUPLER -
LONG SHAFT**
Universal application

DIODES

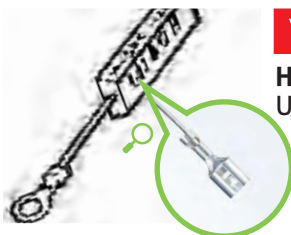

SMWD

HIGH VOLTAGE DIODE
Universal application



SMWD2

**HIGH VOLTAGE DIODE AND
SHORT PROTECTOR**
Universal application



FUSES

CERAMIC FUSES



**32 x 6mm CERAMIC FUSE -
PACK OF 10**
SSF6 - 6 AMP
SSF10 - 10AMP
SSF15 - 15AMP
SSF20 - 20AMP
SSF25 - 25AMP

CERAMIC FUSES



**20 x 5mm CERAMIC FUSE -
PACK OF 10 (SLOW BLOW)**
SCFM6 - 6 AMP
SCFM8 - 8AMP
SCFM10 - 10AMP
SCFM15 - 15AMP

SHVF1



HIGH VOLTAGE FUSE
1AMP 5,7Kv high voltage
fuse in holder with leads
700mA

SMWF63



**MICROWAVE NOISE FILTER -
6,3 Amp**
Universal application

LAMPS

SOL2



PYGMY LAMP - LARGE BULB
25W - SES (E14) - 300 degC
MAX

SOL3



LAMP - 220V
15w - SES (E14) - 300 degC
MAX

SOL4



LAMP - 220V
25w - SES (E14)

SOL7



LAMP - 220V
15w - large SES (E16)

SOL9

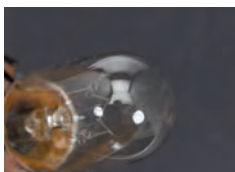

LAMP AND BRACKET - 220v
20w - bracket mount

SOL11



**M/WAVE LAMP WITH
HOLDER 25W**
VARIOUS BRANDS
INCLUDING LG MODELS -MC-
7844, MC-805, MC-9243,
MC-9247, MC-924

SOL14



HALOGEN LAMP 120V 20W
Variuos microwave ovens
OEM REF: 3513602600

MAGNETRONS



LG-2B71732F

MAGNETRON
MC8044, MC8083, MG-583MC, MG-604



SMAG02

MAGNETRON: 650-850w
Replaces:- A6701, 2M172, S107H, 2M189AM4, 2M128D1, 2M172H(CB.N), OM75A(20), 2M107(79), OM75(20), 2M219H, 2M167B-M12, 2M167A-M14, 2M167C, 2M167A-M12, 2M240H(IF), 2M218H(ME)



SMAG06

MAGNETRON: 650-850w 2M226
Replaces:- 670 FOH, 2M204 M1, 2M172FJB, 2M226, 2M157 M1, 2M107A 325, OM75(11), 2M161, 2M210 M1, S107FJB, 2M214, 2M210-M1C, 2M240K(JT), 2M175A, 2M240E(HS), 2M218H, 2M167B-M23



SMAG10

MAGNETRON: 1100w 2M246
Equivalent To:- S107FJB, 2M107A 325, AM670 FOH, 2M247 FOH



SMAG13

MAGNETRON: 650-850w 2M21439F
2M218JS FITS DAEWOO MICROWAVES:- KOC970T, KOC985T, KOG846T, KOR161H



SMAG01

MAGNETRON: 650-850w
2M107:(11)/ (66)/ (82)/ (95)/ (96) (97), 2M128, 2M142, 2M157/M2/ M2B, 2M161(09), 2M167BM10, 2M172JA/B, 2M181, 2M204-M3, 2M218J, 2M219J, A6700, FVMZ0108WRK, H3801(01)



SMAG04

MAGNETRON: 450-550w
Replaces:- OM52S(10)-D, 2M213, 2M211-B, 2M211-M3, 2M230H (1F)



SMAG07

MAGNETRON: 650-850w
Replaces:- 6700H, 2M214(39), 2M172JB, 2M172JAJ, 2M167B, 2M204 M3, 2M107A, 2M219 JB, 2M167, S107JB, 2M240JY, 2M226JB, 2M181-M1, 2M172AJ-L1, 2M224



SMAG12

MAGNETRON: 650-850w 2M218HS FITS DAEWOO MICROWAVES:- KOG390A, KOR61852S, KOR63050S, KOR860AOS, LG MODEL: MG358MC



SMAG18

MAGNETRON - 1000W
LG microwave - MS-5042DP, MS-4847S, MS-4849S



MOTORS



SMTM

TURNTABLE DRIVE MOTOR
DEFY microwave - most early motors; this motor also fits many other makes



SMTM1

TURNTABLE MOTOR 5mm - 'D' SHAFT
Universal application



SMTM2

TURNTABLE MOTOR 6mm - 'D' SHAFT
KIC microwave - SK280E, some DAEWOO models



SMTM5

MOTOR, SYNCHRONOUS
LG microwave - MS-1924W, MS-1924WS, MS-4042DP, MS-5042DP, MS-3045W, MS-304WB

PAINT



SMWCP

IVORY CAVITY PAINT - 350ml
Universal application



SMWCP1

WHITE CAVITY PAINT - 350ml
Universal application

SWITCHES



SW1

3 TAG UNIVERSAL MICRO SWITCH
Normally closed + normally open



SW19

MICROSWITCH 3 CONTACT - SHORT ARM
NORMALLY OPEN, NORMALLY CLOSED

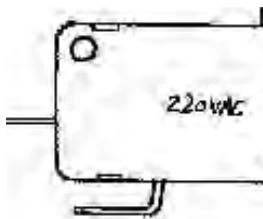

SW20

2 TAG UNIVERSAL MICRO SWITCH
Normally open



SW21

2 TAG UNIVERSAL MICRO SWITCH
Normally closed



SW22

MICROSWITCH, MINI 3 CONTACT
NORMALLY OPEN, NORMALLY CLOSED



SW30

3 TAG UNIVERSAL MICRO SWITCH
Normally closed + normally open - long arm

THERMOSTATS

TST150

KLIXON THERMOSTAT
150degC CUT-OUT



TIMERS & CONTROL UNITS

LG-6871W1S113E

PC BOARD
LG M/WAVE - MG-60
604WB, MG-604WS



TRANSFORMERS

SMTF

**1000W H.V. M/WAVE
TRANSFORMER**
Universal application



SMTF8

**800W H.V. M/WAVE
TRANSFORMER**
Universal application





TRAYS



LG-1B71018G

GLASS TRAY CLOVER
(305 MM)
MC7844/7847/MD-2742/
MH7044/7047/MS272



LG-3390W1A013F

TRAY ASSEMBLY - ENAMEL
MP-9483/9485/9488



LG-3390W1A029A

GLASS TRAY
MC-8044/8045/9246/9247,
MG-6045



LG-3390W1A035D

GLASS TRAY
MS1924, MS1947



LG-3390W1G003G

TRAY, GLASS
MS3045N, MS3047GB,
MS3047GS



LG-3390W1G005A

GLASS TRAY - 245mm
DIAMETER
LG microwaves - MS190,
MS191, MS198
ORIGINAL PART



LG-3390W1G005D

TRAY, GLASS 305MM
CLOVER
MS1913/8,
MS2012/2022/2023



SMTT01

GLASS, TRAY 270mm 3LEG
COUPLER
National microwave - most
models



SMTT03

GLASS, TRAY 315mm 3LEG
COUPLER
National microwave - most
models



SMTT06

GLASS, TRAY 255mm 3LEG
COUPLER
National microwave - most
models

TRAYS

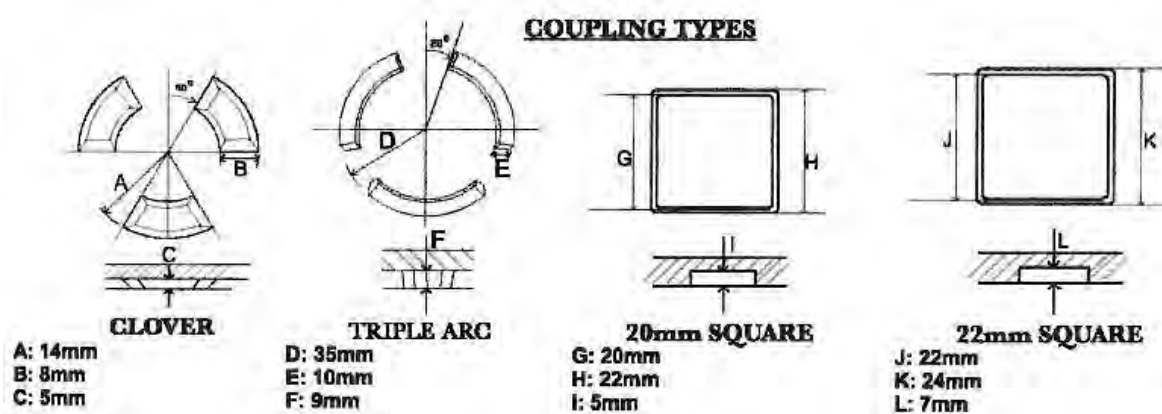

LG-1B71018G

305MM DIAMETER - CLOVER
LG MICROWAVES - MC7844/7847/MD2742/MH7044/7047/MS272 | OEM REF: 3390W1G005D

LG-3390W1A029B

340MM DIAMETER - CLOVER COUPLING
LG MICROWAVES - MC-8044/8045/9246/9246/MG6045

LG-3390W1G003G

284MM DIAMETER - PLAIN
LG MICROWAVES - MS3045N, MS3047GB, MS3047GS

SMTT01

270MM DIAMETER - CLOVER COUPLING
NU-TEC MICROWAVE - SUN0028, NMO-019; UNIVERSAL APPLICATION

SMTT02

288MM DIAMETER - CLOVER COUPLING
UNIVERSAL APPLICATION

SMTT03

315MM DIAMETER - CLOVER COUPLING
KIC MICROWAVE - MWS290; NU-TEC MICROWAVE SUN0030, UNIVERSAL APPLICATION

SMTT06

255MM DIAMETER - CLOVER COUPLING
UNIVERSAL APPLICATION

SMTT11

245MM DIAMETER - PLAIN
LG MICROWAVES - MS190, MS191, MS198 | OEM REF: 3390W1G005A

SMTT12

325MM DIAMETER - CLOVER COUPLING
LG MICROWAVES - MA11645, MC924J | OEM REF: 1B71961E

SMTT13

320MM DIAMETER - PLAIN
LG MICROWAVES - MS365SD, MS428, MS194 | OEM REF: 3390W1G004A



07



COMMERCIAL & CATERING EQUIPMENT



BELTS



XBCD4819

**BELT BOWL TB2-480
BCE CUTTER CT35**



XSLB0232

**FLAT BELT - TB2-67
BCE SLICER BETA**



XSL50031

**FLAT BELT - TB2-330
BCE SLICER - STEL**



XSL51056

**BELT - TB2-345
BCE SLICER - START 300**

ELEMENTS



KBM01

**BAIN MARIE ELEMENT
1500W - NARROW
Suitable for BAIN MARIE**



KBM02

**BAIN MARIE ELEMENT
1500W - WIDE
Suitable with BAIN MARIE**



KBM02A

**BAIN MARIE ELEMENT
1500W - WIDE (16MM
BUSH)
Suitable for BAIN MARIE**



KBM03

**ELEMENT, BAIN MARIE
VERTICAL MOUNT
Suitable for BAIN MARIE &
VULCAN**

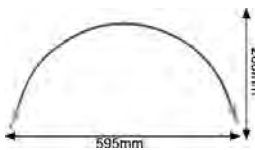

KBM04

**ELEMENT, BAIN MARIE 1/2
MOON
Suitable for BAIN MARIE**



KBM05

**ELEMENT, BAIN MARIE
3000W 230V
Suitable for BAIN MARIE**



KBM06

**BAIN MARIE 3KW SPAZA
Suitable for BAIN MARIE**



KBM07

**STERILIZER ELEMENT 3KW
Suitable for BAIN MARIE &
STERILIZER**



KBM08

**B/MARIE / STERILIZER
ELEMENT 2KW**
Suitable for BAIN MARIE &
STERILIZER



KBM09

MINI BOILER ELE.2000W
11.2DIA.
Universal application



KEG23

**ELEMENT, 3x1.33KW 400MM
H/WATER**
Universal application



KEG30

**JACUZZI ELEMENT WITH
EXTERNAL NUT**
Universal application



KEG37

INDUSTRIAL TANK ELMNT
3x3kW HW (ORANGE)
Universal application



KEG38

INDUSTRIAL TANK ELMNT
3x4kW HW (BLUE)
Universal application



KEG39

3x1000W OIL IMMERSION
1 1/4" BOSS
Universal application



KEG42

UNITHERM BOILER ELMNT
2KW WITHOUT POCKET
Universal application



KEG43

UNITHERM BOILER ELMNT
3KW WITHOUT POCKET
Universal application



KEG45

**ELEMENT 3 x 2KW - HARD
WATER**
Universal application



KEG46

BOILER ELEMENT 1500W
Universal application



KEG63

**4000W TANK ELEMENT
VULCAN** rinse tank



KEG64

BOILING POT ELEMENT - 3kW
Universal application



KFFE01

FISH FRYER ELEMENT 2500W
Universal application



KFFE02

FISH FRYER ELEMENT 3KW
Universal application



KFFE03

FISH FRYER ELEMENT 1500W
Universal application



KFFE04

FISH FRYER ELEMENT (DEEP) 2500W
Universal application



KFFE05

FISH FRYER ELEMENT (DEEP) 2500W
Universal application



KFFE06

FISH FRYER ELEMENT 3 PHASE, 3X4KW
Universal application



KFFE08

FISH FRYER TRIPLE ELEMENT 2666W 230V
Universal application



KFFE09

FISH FRYER ELEMENT
Universal application

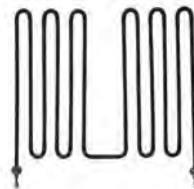

KFFE11B

VULCAN FISH FRYER 5.3.KW
Suitable for VULCAN

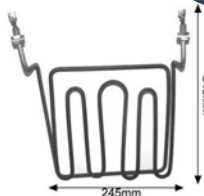

KFFE14

FISH FRY ELEMENT 3500W 230V
Universal application



KGE01

INNER GRILL ELEMENT 2000W
Suitable with VULCAN

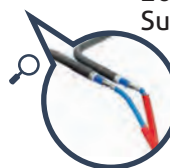

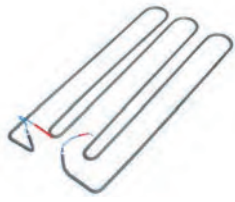

KGE02
OUTER GRILL ELEMENT
 2000W
 Suitable for PRESIDENT

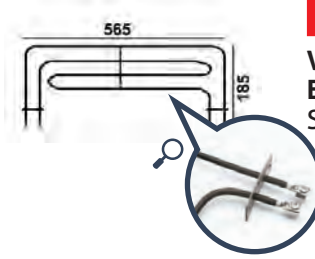

KGE03
VULCAN ALOE KF21 GRILLER ELEMENT
 3000W
 Suitable for VULCAN

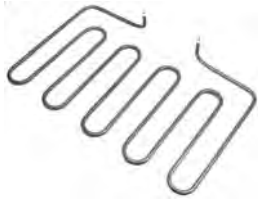

KGE04
PRESIDENT GRILL ELEMENT
 4000W
 Universal application

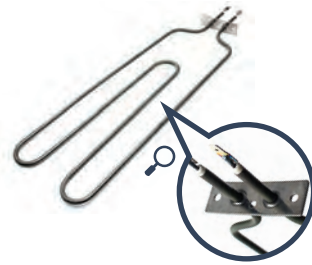

KGE05
INNER GRILL ELEMENT
 2000W
 Suitable for table top grillers

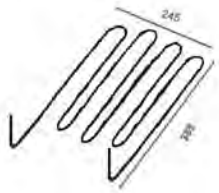

KGE06
GRILL ELEMENT 3000W
 Universal application

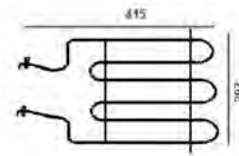

KGE07
SMOKELESS GRILLER ELEMENT
 2100W
 Universal application

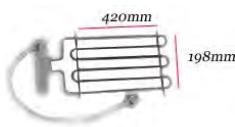

KGE08
CHICKEN GRILLER ELEMENT
 1250W 380V
 Universal application
 (for 227V & 220V see KGE18)



KGE11
ELEMENT CHICKEN GRILL
 GOOSE NECK 11.2MM DIA.
 Universal application



KGE12
ZIG ZAG GRILL ELEMENT
 2000W
 Universal application



KGE13
INDUSTRIAL GRILL ELEMENT
 3000W 380V
 Universal application



KGE14
CHICKEN GRILLER STRAIGHT
 - 11.2mm DIAM.
 Universal application



KGE15
4000W MULTI-COIL ELEMENT
 Universal application

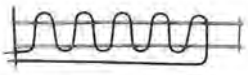

KGE16
ZIG ZAG GRILL ELEMENT
2000
Universal application



KGE17
NUTRI STAHL GRILL ELEMENT
Universal application



KGE18
INDUSTRIAL BAKE ELEMENT
1250W 227V
Universal application for
380V see KGE08

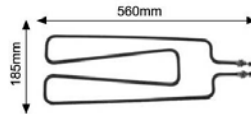

KGE21
INDUSTRIAL OVEN ELEMENT
1500W 230V
Commercial grillers

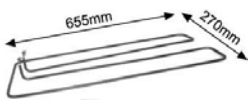

KGE23
4KW TILT PAN ELEMENT
Commercial tilt pan

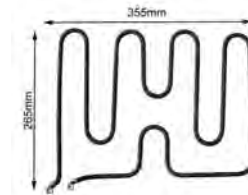

KGE24
ELEMENT 1500W ANVIL GRILLER

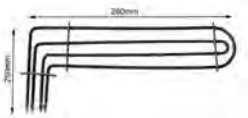

KGE27
ELEMENT 3000W ANVIL convection oven



KGE30
GRILL ELEMENT SALAMANDER/ANVIL griller



KGE31
GRILL ELEMENT
Chip / chicken grillers



KGE32
GRILL ELEMENT SALAMANDER/ANVIL griller



KGE33
GRILL ELEMENT ANVIL hot food bar

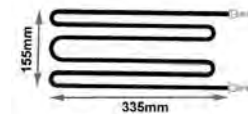

KGE37
GRILL ELEMENT 2660W 230V VULCAN grillers
OEM REF: 301733



KGE38

GRIDDLE ELEMENT 1666W
VULCAN fry-top griddle
OEM REF: 301707



KGE40

ELEMENT - 900w
Fits VULCAN SALAMANDER
OEM REF: 9700449



KGE41

OVEN ELEMENT - 2kW
VULCAN model - RE3
OEM REF: 9700047



KGE54

SPIRAL BEADED ELEMENT
VULCAN tilt pan



KGE55

GRILL ELEMENT
SUNBEAM BBQ grillers



KPE

POPCORN ELEMENT
Commercial toasters



KSME

SEALING MACHINE ELEMENT
535mm 150W
Universal application

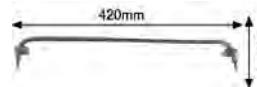

KSME2

SEALING MACHINE ELEMENT
410mm 125W
Universal application



KSME3

MICA SEALING MACHINE ELEMENT



KTE01

TOASTER OUTER 1500W
Commercial toasters



KTE02
TOASTER INNER 1500W
Commercial toasters



KTE04
TOASTER ELEMENT 1250W
Commercial toasters

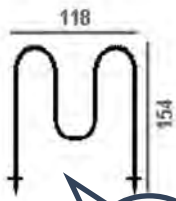

KTE06
ELEMENT, TOASTER 450W
Commercial toasters



KTE08
TOASTER ELEMENT BOTTOM
Commercial toasters

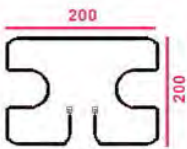

KTE10
TOASTER ELEMENT - 1000W
Commercial toasters



KTE12
TOASTER ELEMENT - 1000w
Various toasters

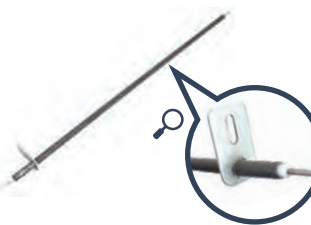

KTE14
STRAIGHT ELEMENT 400MM
500W
Commercial toasters



KTE03
TOASTER ELEMENT 950W
Commercial toasters



KTE05
ELEMENT, TOASTER 1200W
Commercial toasters



KTE07
ELEMENT TOP - 1000W
Commercial toasters



KTE09
ELEMENT, TOASTER 1150W
VULCAN and **SCIENTIFIC**
ENGINEERING toasters

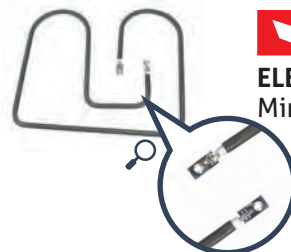

KTE11
ELEMENT 900 + 300w
Mini oven



KTE13
WAFFLE MACHINE ELEMENT
Commercial toasters

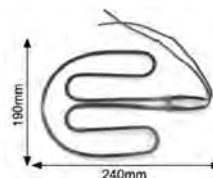

KTE16
ROUND TOASTER ELEMENT
650W 230V
Commercial toasters



KTE17
VULCAN TILT PAN ELEMENT
 VULCAN tilt pan element



KTE19
OUTER ELEMENT 1000W
 230V
 Commercial toasters



KTE21
ELEMENT, TOP 1300W
 TOASTER
 Commercial toasters



KTE23
ELEM. TOP ANVIL CONEY.
 TOAST
 Commercial toasters



KTE25
ELEM. 450W TOASTER ANVIL
 TSA004
 Commercial toasters



VP30043505
STEAM ELEMENT - 3kW
 VULCAN model COS10/20



VP730709
ELEMENT BRACKET
 Universal application



KTE18
1650W BUTTERFLY ELEMENT
 Commercial toasters

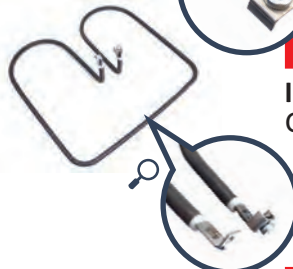

KTE20
INNER ELEMENT 750W 230V
 Commercial toasters

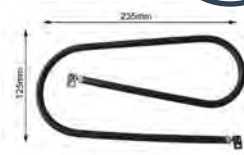

KTE22
ELEMENT TOP SILEX 1300W
 Commercial toasters



KTE24
ELEM. BOTT ANVIL COVEY
 TOASTER
 Commercial toasters



VP2028113028
VULCAN C0512010 BAKE
 ELEMENT
 VULCAN model COS10/20



VP700347
TANK ELEMENT - 3000w
 VULCAN Dishwasher -
 VC130



XHSM2001
HEATING WIRE; 200MM
 HAND SEAL
 Heating wire; 200MM hand
 seal



XHSM3001
**HEATING WIRE 300MM
 HAND SEALER**
 Heating wire 300MM hand
 sealer



XHSM4001
**HEATING WIRE 400MM
 HAND SEALER**
 Heating wire 400MM hand
 sealer



XHSM5001
**HEATING WIRE 500MM
 HAND SEALER**
 Heating wire 500MM hand
 sealer



XSAA0001
**ELEM.QUARTZ, ANVIL
 SALAMANDER**
 ELEM.QUARTZ, ANVIL
 SALAMANDER



XWMW0380
**HEATING WIRE
 380MM;WRAPP MACH**
 Heating wire 380MM-wrapp
 mach

ELEMENTS: URNS



KE739
**UNIVERSAL KETTLE ELEMENT
 AND CORD - 2,4kw**
 Suitable with many makes
 of early kettles

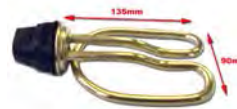

KE740
**UNIVERSAL KETTLE
 ELEMENT - 2,4kw**
 Suitable with many makes
 of early kettles



KE740C
**UNITHERM UNIVERSAL
 KETTLE ELEMENT - 2.5Kw**



KEU01
URN ELEMENT - 2 x 1000w
 Without pocket



KEU02
URN ELEMENT - 2 x 1500w
 Without pocket



KEU03
URN ELEMENT - 2 x 2000w
 Without pocket



KEU04
URN ELEMENT - 2 x 1000w
 With pocket



KEU05
URN ELEMENT - 2 x 1500w
 With pocket



KEU06
URN ELEMENT - 2 x 2000w
 With pocket



KEU09
L619 HENDLER URN ELEMENT - 2000w
 With cut-out klixon



KEU10
L619 HENDLER URN ELEMENT - 3000w
 With cut-out klixon



KEU11
HENDLER / KWIKHOT URN ELEMENT - 1500w
 With cut-out klixon



KEU14
ELEMENT, URN 2.7KW
 ANVIL urns

ELEMENTS: GRILLER, HOT TROLLEYS



KHHE
WARMER ELEMENT - 750W
 ECHO HOSTESS trolley - all models
 maitre d' trolley - all models



SPED01
PLATE ELEMENT - E12
 DEFY RAYBURN - E12

ELEMENTS: INFRA-RED



KHBL01
I/RED HEATING LAMP
 350MM 1000W
 Chicken grillers



KHBL02
INFRA-RED ELEMENT 1000W
 357MM
 Chicken grillers



KHBL03
I/RED HEATING LAMP 500W
 227MM
 Chicken grillers



KHBL04
INFRA-RED LAMP 335MM
 1KW+CLIPS
 Chicken grillers



KHBL05
INFRA-RED HEATING ELEMENT - 1300W 130MM DIAM.
 Various applications - including fan heaters, water heaters & grillers

ELEMENTS: INFRA - RED



KGE34
CERAMIC ELEMENT - 245MM
 150W, 400W, 750W, 1000W
 Used in warmers, grillers & moulding

KGE35

KGE36

KGE53

HEATING ELEMENTS



S12.30452.114
INDUSTRIAL PLATE 300mm
 2.5KW
 DEFY cooker - RAYBURN E12 round plate



S32.06002.007
BAR, HEATING 700W 380V
 600mm
 Commercial cookers



SHB1
HEATING BAR - 300W
 UNIVA stoves - early models

KNOBS



SNB524807
KNOB, CONTROL CAL.0-
 300C 6mm
 Suitable with part number: S0TH53E



VP700272
FISH FRYER KNOB
 110-180°C
 Universal application



VP700275

GRILLER KNOB 0-300°C
Universal application



VP700276

3 HEAT KNOB
Universal application



VP720105

KNOB - GAS VALVE
VULCAN - Mk V

MISCELLANEOUS



XBMX5220

COUPLING KIT BER/MIX
(B3000)
Coupling kit ber/mix
(B3000)



XHSM3002

TEFLON STR(300MM) HAND
SEAL MA
TEFLON STR(300MM) hand
seal MA



XHSM5002

TEFLON STR(500MM)HAND
SEAL MAC
TEFLON STR(500MM)hand
seal MAC

SEALS



SDS55

INDUSTRIAL OVEN SEAL
Universal application

THERMOMETERS & SWITCHES



460

OVEN THERMOMETER
0-300°C
UNIVERSAL APPLICATION



KVKF11-C

VKF11 CONTACTOR 60-
115°C
UNIVERSAL APPLICATION



SOTH52

THERMOSTAT, 50-190C
KNOB & BEZEL
50 - 190degC - 16AMP MAX.
Complete with knob and bezel



SOTH52A

KNOB 50-190C
for use on SOTH52 50-190 degC



SOTH53E

THERMOSTAT, 3 PHASE
380V 30A
0-300degC - 30AMP MAX.
EGO REF: 55.34052.010



SOTH54

THERMOSTAT, 4-40C KNOB & BEZ
4-40degC - 16AMP MAX.
Complete with knob and bezel



SOTH54A

KNOB 4-40C
For use on SOTH54 4-40 deg C



SOTH54C

THERMOSTAT 4-40C KNOB & BEZEL
Universal application



SOTH54U

THERMOSTAT 0-40C+KNOB & BEZEL
Universal application



SOTH55

THERMOSTAT, 30-110C
KNOB & BEZ
30 - 110 deg C - 16AMP MAX. Complete with knob and bezel



SOTH55A

KNOB 30-110C
For use on SOTH55 30 - 110 deg C



SOTH55C

THERMOSTAT 30-110C
KNOB & BEZ
UNITHERM thermostat 30 - 110 deg C knob & bez



SOTH55U

THERMOSTAT 30-110C+KNB & BEZEL
Universal application



SOTH56

THERMOSTAT, 50-220C
KNOB & BEZ
50 - 220 deg C - 16AMP MAX. Complete with knob and bezel



SOTH56C

THERMOSTAT 50-220C
KNOB & BEZ
Universal application



SOTH57

T/STAT 190D EGO
55.13632.050
EGO thermostat 105-190 deg C



SOTH58

THERMOSTAT 30-150C
KNOB & BEZEL
30-150 deg C



SOTH59

T/STAT 110D EGO
55.13022.020
Fits BAIN MARIE & VULCAN



SOTH61

T/STAT RESET EGO
55.13542.200
ZDSEF0-220 deg C fits
VULCAN fish fryers



SOTH62

CATERING THERMOSTAT
30 -90 deg C - 16AMP MAX.
3 contacts - without knob



SOTH62U

THERMOSTAT 30-90C+KNOB
& BEZEL
Universal application



SOTH63

CATERING THERMOSTAT
210 deg C - 16AMP MAX.
Manual reset



SOTH64

BOILING POT THERMOSTAT
0-160 deg C universal
application



SOTH65

DOUBLE THERMOSTAT
Variable 50 -190 deg C +
manual reset 210 deg C -
universal application



SOTH66

THERMOSTAT
0 -60 deg C - universal
application - with knob and
bezel



SOTH67

THERMOSTAT 0-50C+KNOB
& BEZEL
Universal application



SOTH68

TILT PAN THERMOSTAT
KT FR HYDRO BOILS



SOTH70

THERMOSTAT EASP 492-48,
30A VARIOUS APPLICATIONS



SOTH71

REPLACEMENT THERMOSTAT
VULCAN model - RE3



SW24032

3 HEAT ROTARY SELECTOR
SWITCH
VULCAN model - RE3



XWBA0003

T/STAT, WAFFLE BAKER
ANVIL
T/stat, waffle baker ANVIL



XWMW1002

ROCKER SWITCH -
2 CONTACT
WRAPMASTER



LENGTH		
FROM	TO	MULTIPLY BY:
Kilometers (km)	Miles (mi)	0.62
Kilometers (km)	Feet (ft)	3280.8
Meters (m)	Feet (ft)	3.28
Centimeters (cm)	Inches (in)	0.39
Millimeters (mm)	Inches (in)	0.039
Inches (in)	Meters (m)	0.0254
Inches (in)	Centimeters (cm)	2.54
Inches (in)	Millimeters (mm)	25.40
Feet (ft)	Meters (m)	0.30
Yards (yd)	Meters (m)	0.91
Yards (yd)	Kilometers (km)	0.00091
Miles (mi)	Kilometers (km)	1.61

VOLUME		
FROM	TO	MULTIPLY BY:
Liters (l)	Quarts (qt)	1.057
Liters (l)	Gallons (gal)	0.264
Milliliters (ml)	Cups (c)	0.0042
Milliliters (ml)	Ounces (oz)	0.0338
Ounces (oz)	Milliliters (ml)	29.57
Cups (c)	Milliliters (ml)	236.6
Quarts (qt)	Liters (l)	0.95
Gallons (gal)	Liters (l)	3.785

MASS		
FROM	TO	MULTIPLY BY:
Kilogram (kg)	Tons (ton)	0.0011
Kilogram (kg)	Pounds (lb)	2.2046
Grams (g)	Ounces (oz)	0.035
Grams (g)	Pounds (lb)	0.002205
Milligrams (mg)	Ounces (oz)	0.000035
Ounces (oz)	Milligrams (mg)	28350
Ounces	Grams (g)	28.35
Pounds (lb)	Kilograms (kg)	0.454
Tons (ton)	Kilograms (kg)	907.18

CONVERSION CHART

TEMPERATURE		
FROM	TO	CONVERSION
Fahrenheit (F)	Celsius (C)	$(\text{Temperature (F)} - 32) * 5/9$
Celsius (C)	Fahrenheit (F)	$(\text{Temperature (C)} * 9/5) + 32$

ELEMENTS		
Element		Will Draw
Watt	Kilowatt	(220V)
50 Watt	0,05 Kw	0,23 Amps
100	0,1 Kw	0,45 Amps
150	0,15 Kw	0,68 Amps
200	0,2 Kw	0,91 Amps
400	0,4 Kw	1,81 Amps
500	0,5 Kw	2,27 Amps
750	0,75 Kw	3,40 Amps
1000	1 Kw	4,55 Amps
1500	1,5 Kw	6,82 Amps
2000	2 Kw	9,09 Amps
2500	2,5 Kw	11,36 Amps
3000	3 Kw	13,64 Amps
3500	3,5 Kw	15,91 Amps
4000	4 Kw	18,19 Amps

FRACTION, HP & WATT		
FRACTION	HP	WATT
1/20	0,05	37,28
1/15	0,065	48,47
1/12	0,083	61,89
1/10	0,1	74,57
1/8	0,125	93,21
1/7	0,143	106,64
1/6	0,166	123,79
1/5	0,2	149,14
1/4	0,25	186,42
1/3	0,33	246,08
3/8	0,75	279,64
1/2	0,5	372,85
3/4	0,75	559,27
1	1,00	745,70



YOUR NEAREST BRANCH

GAUTENG

NORTH GAUTENG - RANDBURG (STRIJDOM PARK)

Unit G11 Commercial City,
Tungsten Road cnr Malibongwe,
Strijdom Park, Randburg
Tel: (011) 791 7668 | Fax: (011) 791 7648

WEST GAUTENG - ROODEPOORT

136A Albertina Sisulu Road, Unit 22 Federal
Industrial Park, Manufacture, Roodepoort
Tel: (011) 760 1211/2 | Fax: (011) 760 1247

SOUTH GAUTENG - TULISA PARK

25 Brunel Road cnr Heidelberg Road
Tulisa Park, Johannesburg
Tel: (011) 613 6551 | Fax: (011) 613 6557

SOUTH GAUTENG - VANDERBIJLPARK

26 Edison Boulevard
Vanderbijlpark
Tel: (016) 981 8957/8 | Fax: (016) 981 8956

EAST GAUTENG - BOKSBURG

Unit 1A Engen Garage,
Cnr Atlas & Top Road, Boksburg
Tel: (011) 894 7781 | Fax: (011) 894 4891

PRETORIA - GEZINA

504 Steve Biko Road,
Pretoria (Gezina)
Tel: (012) 335 7408 | Fax: (012) 335 7467

PRETORIA - PRETORIA WEST

270 Soutter Street,
Pretoria West, Pretoria
Tel: (012) 327 3186 | Fax: (012) 327 3190

NORTH WEST

KLERKSDORP

17 Delver Street,
CBD Klerksdorp
Tel: (018) 464 4294 | Fax: (018) 462 8754

RUSTENBURG

Shop 8, Platinum Square,
49 Nelson Mandela Drive, Rustenburg
Tel: (014) 597 0079 | Fax: (014) 597 0297

FREE STATE

BLOEMFONTEIN

29 Blignaut Street, Hilton,
Bloemfontein
Tel: (051) 447 2622 | Fax: (051) 430 1810

LIMPOPO

POLOKWANE

80A Bok Street, Polokwane,
Tel: (015) 297 7992 or (015) 297 1875
Fax: (015) 297 5038

MPUMALANGA

NELSPRUIT

Unit 22 Christie Crescent
Vintonia Ext 2, Nelspruit
Tel: (013) 752 6864 | Fax: (013) 755 4870

KWAZULU NATAL

PIETERMARITZBURG

305 Greyling Street
Pietermaritzburg
Tel: (033) 345 7873 | Fax: (033) 345 8013

RICHARDS BAY

Unit 5 Caremic Park, 20 Caremic Curve
Alton, Richards Bay
Tel: (035) 751 2721 | Fax: (035) 751 2724

DURBAN - SPRINGFIELD PARK

Unit 4 Umgeni Business Park, 23 Intersite
Avenue, Springfield Park, Durban
Tel: (031) 263 1783 | Fax: (031) 263 2168

EASTERN CAPE

PORT ELIZABETH

17 North Road, North End,
Port Elizabeth
Tel: (041) 484 2298 | Fax: (041) 484 2391

EAST LONDON

21 Paterson Street, Arcadia,
East London
Tel: (043) 722 7124 | Fax: (043) 722 6790

WESTERN CAPE

CAPE TOWN - PAARDEN EILAND

126 Marine Drive, Paarden Eiland,
Cape Town
Tel: (021) 492 1490 | Fax: (021) 511 5806

GEORGE

1 Fabriek Street, Old Industria,
George
Tel: (044) 873 5323 | Fax: (044) 873 5211

SOMERSET WEST

5 Daniel Street, Gants Plaza,
Strand
Tel: (021) 854 3818 | Fax: (021) 854 4823

AFRICA

NAMIBIA - WINDHOEK

6 Kallie Roodt Street, Northern Industrial Area,
Windhoek
Tel: +264 (0) 61 262 876 | Fax: +264 (0) 61 262 894

BOTSWANA - GABORONE

Unit 4, Plot 5634, Broadhurst,
Gaborone
Tel: +267 (0) 391 9573 | Fax: +267 (0) 391 9574

Your Solutions Partner with 22 branches across
Southern Africa - **086 118 3292**

Visit us online for more info
www.tecsareco.co.za
info@tecsareco.co.za